

An abstract graphic composed of thick, overlapping red and white curved shapes. The shapes create a sense of depth and movement, with some areas appearing to be cutouts or recessed. The overall composition is dynamic and modern.

# PPMS Platform Measurement Options

# Table of Contents

## **PPMS Family**

Specifications 2

## **Electrical Transport**

AC Resistance (ETO) 3

DC Resistance 4

van der Pauw-Hall 5

Pressure Cell (Transport) 6

Horizontal Rotator 7

## **Magnetometry**

Torque Magnetometer (Tq-Mag) 8

Vibrating Sample Magnetometer (VSM) 9

VSM Large Bore Coil Set 10

VSM Oven 11

FORC Software for VSM 12

Fiber Optic Sample Holder (FOSH) 13

Pressure Cell (Magnetometry) 14

AC Susceptibility (ACMS II) 15

## **Thermal Measurements**

Heat Capacity 16

Thermal Transport (TTO) 17-18

Dilatometer 19

## **Sub-Kelvin Capabilities**

Adiabatic Demagnetization Refrigerator (ADR) 20

Helium-3 Refrigerator 21

Dilution Refrigerator 22

Sub-Kelvin Measurement Options 23-24

## **Multi-Function Probes**

MFP Types, Test Stations, Breakout Boxes 25-26

Optical Multifunction Probe (OMFP) 27

**Light Sources** 28

## **Ferromagnetic Resonance (FMR)**

CryoFMR 29

**Compatibility Tables** 30

# PPMS Family

The Quantum Design Physical Property Measurement System (PPMS) represents a unique concept in laboratory equipment: an open architecture, variable temperature and magnetic field system, designed to perform a variety of automated measurements. Use the PPMS with its many purpose-built measurement options, or easily adapt it to your own experiments. These systems provide sample environments from 0.05 to 1000 K and fields up to 16 T.

## PPMS® DynaCool®

The popular PPMS is now available in a truly state-of-the-art cryogen-free package. The PPMS DynaCool uses a single two-stage Pulse Tube cooler to cool both the superconducting magnet and the temperature control system, providing a low vibration environment for sample measurements. The PPMS DynaCool offers continuous low temperature control, precise field and temperature sweep modes, as well as a built-in cryopump.

## PPMS® VersaLab®

The PPMS VersaLab is a portable, cryogen-free, cryocooler-based material characterization platform. With a temperature range of 50 to 400 K, this 3 T platform is perfect for accomplishing many types of materials characterization in a limited space, with no requirements for cryogenic liquids or high power infrastructure.

## Specifications

### DynaCool

Temperature Range*	1.8 to 400 K
Temperature Stability:	$\pm 0.1\%$ ( $T < 20$ K), $\pm 0.02\%$ ( $T > 20$ K); (typical)
Temperature Accuracy:	$\pm 1\%$
Cool Down Time:	40 minutes (typical; time to stable 1.9 K from 300 K)
Field Range:	$\pm 9$ T, $\pm 12$ T, $\pm 14$ T
Field Uniformity**:	9 T: $\pm 0.01\%$ over 3 cm on-axis 12 T: $\pm 0.1\%$ over 5.5 cm on-axis 14 T: $\pm 0.1\%$ over 5.5 cm on-axis
Max Field Charging Rate:	9 T: 200 Oe/s; 12 T: 100 Oe/s; 14 T: 100 Oe/s
Min Field Charging Rate:	9 T: 0.1 Oe/s; 12 T: 0.2 Oe/s; 14 T: 0.2 Oe/s; (typical)
High Vacuum:	$< 0.1$ mTorr

### PPMS

Temperature Range:	1.9 to 400 K
Temperature Stability:	$\pm 0.2\%$ ( $T < 20$ K), $\pm 0.02\%$ ( $T > 20$ K); (typical)
Temperature Accuracy:	$\pm 1\%$
Temperature Sweep Rate:	6 K/min. cooling, 10 K/min. warming; (typical)
Cool Down Time***:	40 minutes (typical; time to stable 1.9 K from 300 K)
Field Range:	$\pm 9$ T, $\pm 14$ T, $\pm 16$ T
Field Uniformity**:	9 T: $\pm 0.01\%$ over 5.5 cm on-axis 14 T: $\pm 0.1\%$ over 5.5 cm on-axis 16 T: $\pm 0.1\%$ over 1.0 cm on-axis
Max Field Charging Rate:	9 T: 190 Oe/s ( $> 1$ T/min) 14 T: 100 Oe/s ( $\approx 0.5$ T/min) 16 T: 160 Oe/s ( $\approx 1$ T/min)
Min Field Charging Rate:	0.1 Oe/s (typical)
High Vacuum (optional)	0.1 mTorr

### VersaLab

Temperature Range:	50 to 400 K
Temperature Stability:	$\pm 0.02\%$
Temperature Accuracy:	$\pm 1\%$
Cool Down Time***:	$< 120$ minutes (time to stable 50 from 300 K)
Field Range:	$\pm 3$ T
Field Uniformity**:	$\pm 0.1\%$ over 2.5 cm on-axis
Max Field Charging Rate:	300 Oe/s
Min Field Charging Rate:	0.1 Oe/s
High Vacuum:	$< 1$ mTorr

\*Stated 1.8 K is for 60 Hz line frequency; 50 Hz line frequency has a base of 1.85 K.

\*\*Uniformity range is centered 4.05 cm above the surface of a standard transport puck; this point represents the center of an installed VSM coilset.

\*\*\*Stated 120 minute cool down time is for 60 Hz line frequency; 50 Hz line frequency has a cool down time of 140 minutes.

Specifications are subject to change without notice.



# Electrical Transport

## AC Resistance (ETO)

DynaCool (D605) / PPMS (P605) / VersaLab (V605)

The Electrical Transport Option (ETO) leverages a digital lock-in technique to measure resistance in a traditional Kelvin sensing (4-probe) configuration across a wide dynamic range; this is extended further by the special 2-probe high-impedance mode for a total range spanning nearly fifteen full decades. The two modes feature 8 M $\Omega$  of overlap so data can be normalized for a complete curve across both ranges. Additional functions like I-V curve profiling and differential resistance measurements extend the utility of the ETO to non-ohmic materials as well as device characterization and screening.

### Key Features:

- Simultaneous measurement of resistance on up to two channels with phase angle and quadrature voltage reported for diagnostics
- Pre-selected frequencies for channels 1 and 2 prevent cross-talk and maximize signal-to-noise
- Two measurement modes: current sourced in standard 4-probe configuration; voltage sourced in high-impedance 2-probe configuration
- I-V curve collection can be used to screen for ohmic contacts
- Preamp is mounted as close to the electrical access point of the PPMS as possible to minimize degradation of small signals occurring before amplification

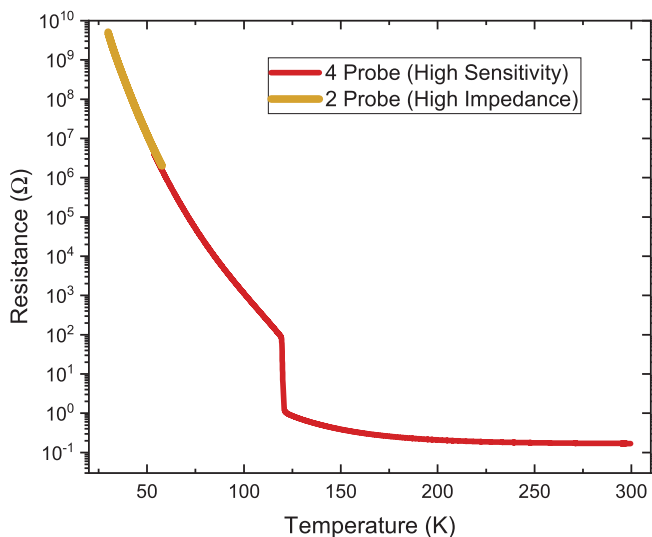

Temperature dependence of the resistance of a magnetite ( $\text{Fe}_3\text{O}_4$ ) mineral sample. The high-resistance data is collected using the 2-probe (high impedance) mode, while the rest of the range is covered by the more conventional 4-probe configuration for increased sensitivity. Note that the Verwey transition can be resolved near 120 K.

## Electrical Transport (ETO) Specifications (for zero-field) (Values refer to the standard 4-probe configuration unless otherwise noted)

### Resistance [R]

Excitation Mode:	AC
Range:	10 $\mu\Omega$ to 10 M $\Omega$ 2 M $\Omega$ to 5 G $\Omega$ (high-impedance 2-probe)
Accuracy*:	$\pm 0.1\%$ typical, $\pm 0.2\%$ maximum; $R < 200$ k $\Omega$ $\pm 0.2\%$ typical; $R \approx 1$ M $\Omega$ $\pm 2.0\%$ typical; $R < 1$ G $\Omega$ (high-impedance) $\pm 5.0\%$ typical; $R = 5$ G $\Omega$ (high-impedance)
Sensitivity:	10 n $\Omega$ RMS typical

### Drive Parameters

Frequency Range:	0.1 to 200 Hz (nominal)
Current Amplitude Range**:	10 nA to 100 mA
Current Amplitude Accuracy:	$\pm 0.4\%$ , 100 nA drive; improves for larger amplitudes
Voltage Amplitude Range:	10 mV to 10 V (high-impedance 2-probe)

**Operational Range** 1.8 to 400 K; 0 to 16 T

\*Accuracy specification depends on sourced current and selected preamp range; stated values describe typical performance for a majority of possible measurement configurations.

\*\*Stated available current range applies to operation at temperatures of 1.8 K and above.

Specifications are subject to change without notice.



ETO Preamp Head

# Electrical Transport

## DC Resistance

DynaCool (D400) / PPMS (P400) / VersaLab (V400)

DC transport for up to three channels on a standard puck can be measured using the DC Resistivity Option for the PPMS®. Bridge channels can be individually configured for various levels of current excitation or power limitation, as well as enabling automated polarity-switch averaging to remove static DC offset voltages.

### Key Features:

- Three multiplexed four-probe measurement channels accessible on a single puck
- Optional fourth channel for customized measurements
- Configurable bridge parameters to limit the voltage, current, or power at the sample for protecting sensitive devices, films, etc.
- Resistivity can be calculated using measured resistance from user-provided sample geometry parameters

## DC Resistivity Specifications (for zero-field)

### Resistance [R]

Excitation Mode: DC  
 Range: 10  $\mu\Omega$  to 5 M $\Omega$   
 Sensitivity: 15 nV RMS typical\*

### Drive Parameters

Current Range: 10 nA to 8 mA  
 Compliance Voltage: 4 V, maximum  
 Frequency: 5 Hz square wave

**Operational Range** 1.8 to 400 K; 0 to 16 T

\*This corresponds to 2  $\mu\Omega$  at 8 mA excitation.  
 Specifications are subject to change without notice.

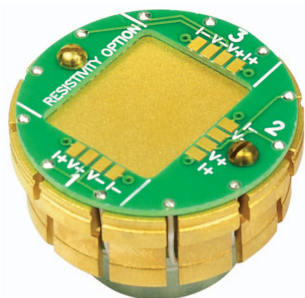

Resistivity Puck

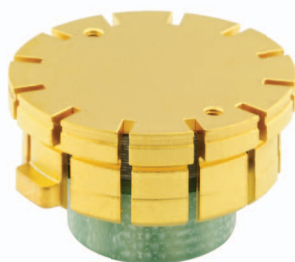

Optional P101  
 Universal Sample Puck



Sample Wiring Test Station

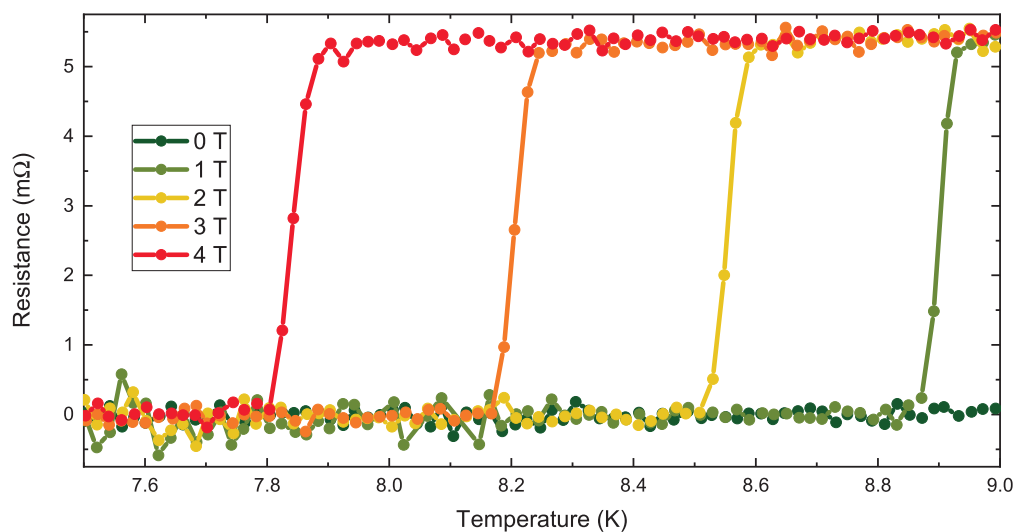

The superconducting transition in a NbTi alloy is shown for a number of fixed magnetic fields demonstrating the field-dependence of  $T_c$ .

# Electrical Transport

## van der Pauw-Hall

DynaCool (D542) / PPMS (P542) / VersaLab (V542)

The van der Pauw technique allows for the determination of a material's resistivity for a sample of arbitrary shape so long as it is uniformly thick. To achieve optimal accuracy using this technique, multiple unique permutations of the current and voltage leads must be measured and properly averaged. The van der Pauw – Hall Option automatically performs these measurements and calculations so highly accurate resistivity measurements can be easily conducted as a function of temperature or magnetic field. The same switching and measurement hardware can further be leveraged to acquire the Hall coefficient and infer the charge carrier concentration with the application of sufficiently strong magnetic fields. With both the resistivity and the Hall coefficient known, the software can automatically calculate the carrier mobility  $\mu$  as a function of temperature across the full range of the PPMS.

## van der Pauw – Hall Transport Specifications\*

### Resistance [R]

Range: 10  $\mu\Omega$  to 5 M $\Omega$   
Sensitivity: 15 nV RMS typical\*\*

### Drive Parameters

Current Range: 2 nA to 8 mA  
Compliance Voltage: 4 V, maximum  
Frequency: 5 Hz square wave

**Operational Range:** 1.8 to 400 K; 0 to 16 T

\*The vdP-H Option uses the DC Resistance hardware for measurements and thus shares its specifications.

\*\*This corresponds to 2  $\mu\Omega$  at 8 mA excitation.

Specifications are subject to change without notice.



Automated switching controller

### Key Features:

- Option software fully integrated to MultiVu, enabling sequence commands to configure a measurement of the van der Pauw resistivity, Hall coefficient, or combined mobility.
- IV-Curve utility allows for a measure of sample contact quality to be made at the start of every single measurement
- Switching wiring permutations is handled automatically by MultiVu for common measurements (vdP, Hall, mobility)

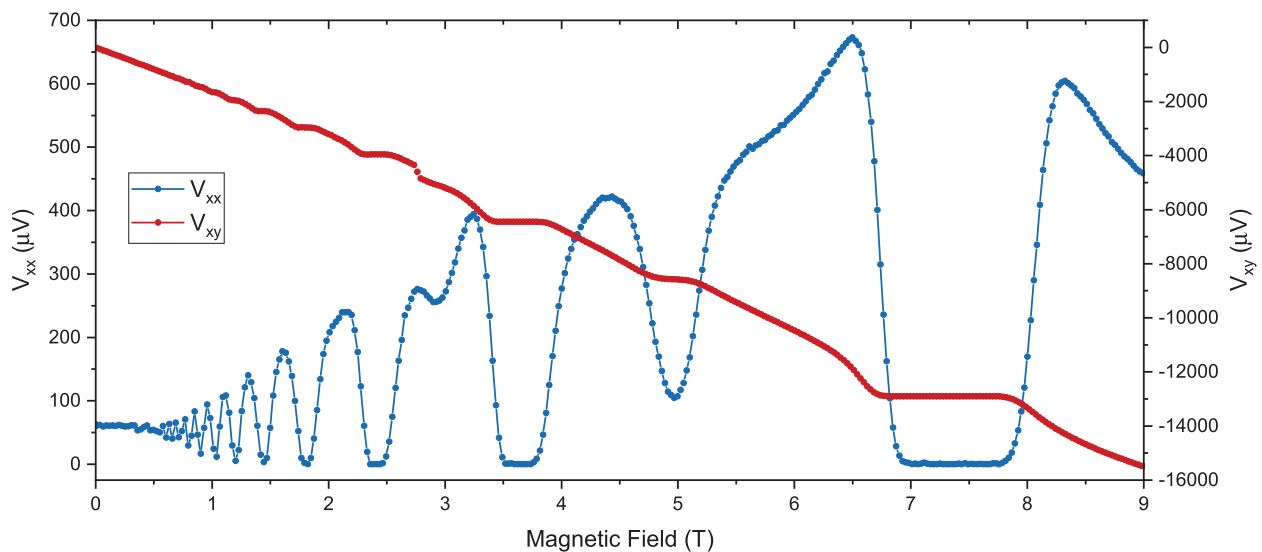

Field-dependent longitudinal and transverse voltage signals measured for a GaAs 2-D electron gas system at 1.7 K with 1  $\mu$ A sourced DC excitation current in the van der Pauw geometry. In the upper frame, plateaux demonstrating the integer quantum Hall effect correspond to where the Fermi level falls in an area of localized states between neighboring Landau levels.

Sample provided by M. Pendharkar, Chris Palmstrøm Group, University of California Santa Barbara.

# Electrical Transport

## Pressure Cell (Transport)

DynaCool (D420) / PPMS (P420) / VersaLab (V420)

Often a sample's electrical transport properties evolve under the application of substantial hydrostatic pressure. The Transport Pressure Cell Option for the PPMS<sup>®</sup> is manufactured by ElectroLab, a leading Japanese supplier of pressure cells. It enables up to two 4-probe measurements (typically for the sample and a manometer) of electrical transport at pressures as high as 2.7 GPa. Samples are mounted to pre-made sets of electrical leads with integrated feedthroughs for pressurization in an oil media using a bench-top press to apply load.

### Key Features:

- Complete kit includes required tools and materials for mounting samples, applying pressure to the cell, and measuring pressure
- Includes manometer materials of tin and lead, whose superconducting transition temperatures can be accurately measured via integrated thermometry which can be used to infer actual cell pressure
- Cell can be installed in the PPMS using standard puck insertion/extraction tool
- Data can be collected with any PPMS-compatible QD transport option
- 10 total sample leads (5 twisted pairs) included with each feedthrough set



### Press specifications

Model	CDM-5PAS (5 ton)	CDM-10PAS (10 ton)
Maximum pressure	70 MPa	70 MPa
Bore area	7.16 cm <sup>2</sup>	14.52 cm <sup>2</sup>
Mass	10 kg	25 kg

Optional – digital pressure gauge

## Pressure Cell (Transport) Specifications

### Pressure [P]

Maximum Sample Pressure: 2.7 GPa  
Maximum Applied Load: 3.0 GPa

### Sample Space Parameters

Diameter: 4 mm  
Length: 6 mm

### Operational Range

1.8 to 400 K; 0 to 16 T

Specifications are subject to change without notice.



High Pressure Cell for Electric Transport Measurements

# Electrical Transport

## Horizontal Rotator

DynaCool (D310) / PPMS (P310) / VersaLab (V310)

Probing the angular dependence (i.e. anisotropy) of the electrical resistance provides key insights into the electronic and crystallographic properties of materials. The Horizontal Rotator enables a sample to be rotated over 360° in the presence of an applied magnetic field spanning the entire temperature range of the base system. An automated indexing procedure and encoder ensures accurate angular positions and the on-board thermometer monitors the temperature in close proximity to the sample.

## Horizontal Rotator Specifications

### Angle [θ]

Range:	-10° to 370°
Angular Step Resolution*:	0.0133°/step (standard resolution) 0.0011°/step (high resolution)
Orientation:	Axis of rotation perpendicular to magnetic field axis <i>and</i> puck key
Backlash:	< 10°

**Operational Range** 1.8 to 400 K; 0 to 16 T

\*Specified resolution is only obtained by driving successive steps in the same direction.

Specifications are subject to change without notice.

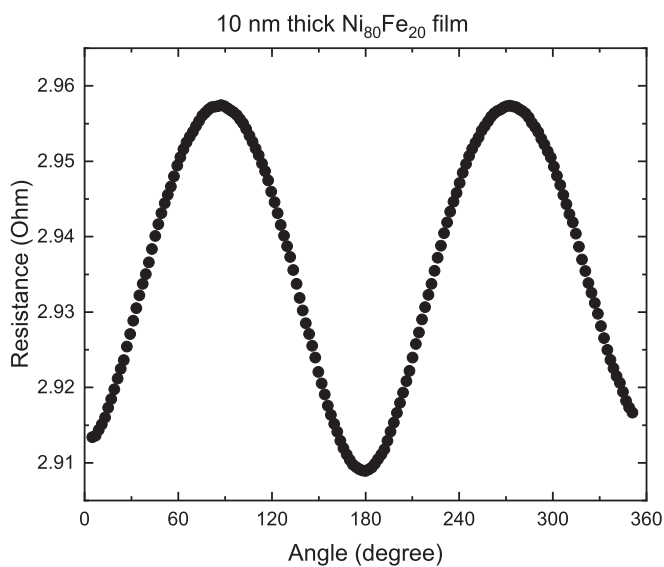

Angular dependence of magnetoresistance measured at 300 K and 1 T using the Resistivity Option in conjunction with the Horizontal Rotator. The 10 nm thick Permalloy film exhibits the expected anisotropic magnetoresistance (AMR) response.

### Key Features:

- Integrated temperature sensor is in direct contact with the installed sample holder
- Materials chosen to minimize magnetic and temperature effects to ensure reproducibility upon cycling environmental parameters
- Two types of sample boards provided – one where the rotation axis remains in the sample plane, and one where the axis points out of the sample plane
- Two channels per sample board, each channel provides 4-probe electrical contacts
- Low- and high-resolution motor options available

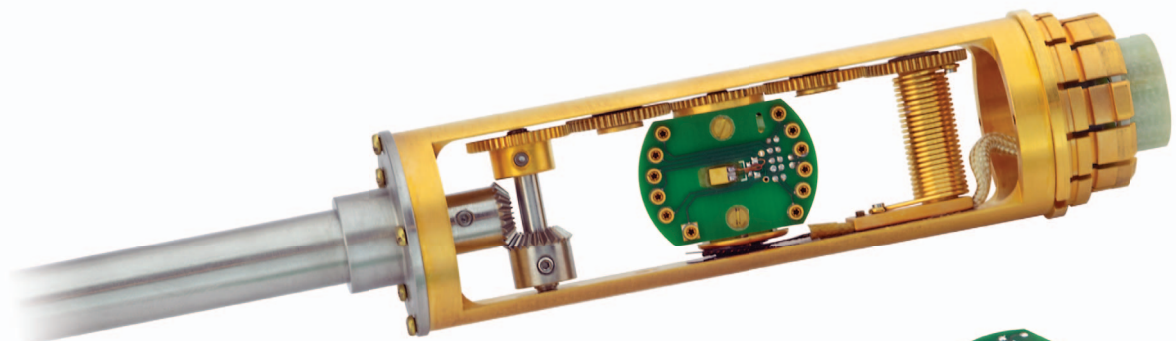

Horizontal Rotator, shown with sample boards designed for Resistivity/ETO (field parallel sample plane), Resistivity/ETO (standard), and the Universal Sample Board.

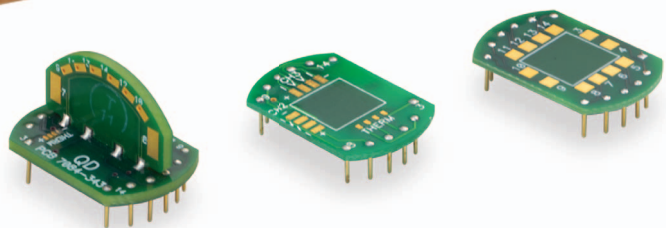

# Magnetometry

## Torque Magnetometer (Tq-Mag)

DynaCool (D550) / PPMS (P550) / VersaLab (V550)

The torque magnetometer (Tq-Mag) measures the torque ( $\tau = \mathbf{m} \times \mathbf{B}$ ) exerted on a magnetic sample with moment,  $\mathbf{m}$ , by an applied field,  $\mathbf{B}$ . By definition, a torque is only present if a component of  $\mathbf{m}$  is orthogonal to  $\mathbf{B}$ . Therefore, torque magnetometry is a powerful tool in the study of small anisotropic single crystals and thin films. The torsion is measured using piezoresistive elements on a calibrated cantilever chip as a function of magnetic field, temperature, or angular orientation. The automated calibration procedure substantially minimizes offsets from gravity and temperature to the measured torque.

### Key Features

- Piezoresistive elements comprising a Wheatstone bridge are fabricated directly on the cantilever chip
- Integrated calibration loop on the cantilever chip
- Sample mounting entails only a small amount of vacuum grease to hold the sample to the cantilever with no additional wiring required
- Two chip variants are available:
  - (i) High-sensitivity chip for low noise ( $1 \cdot 10^{-9}$  N·m)
  - (ii) Large-moment chip which extends the upper range of the measurement to  $1 \cdot 10^{-4}$  N·m

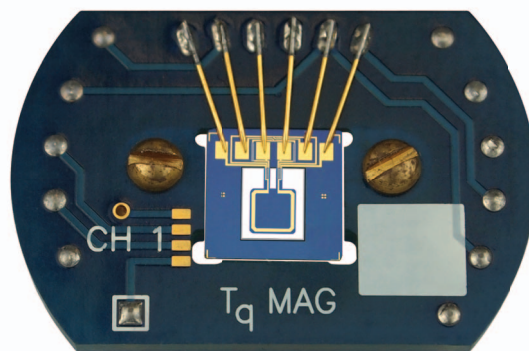

Tq-Mag chip

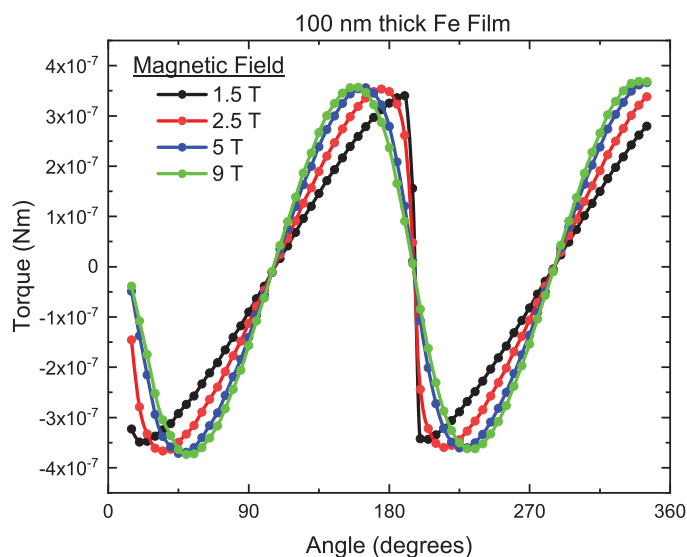
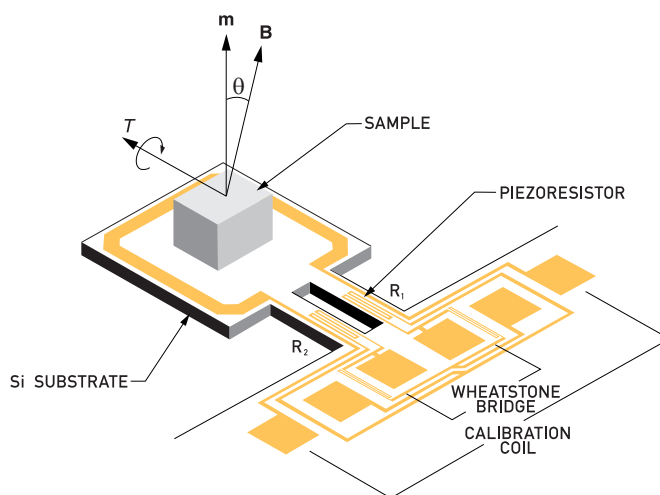

Torque curves measured at room temperature of a 100 nm thick Fe film as a function of the angle of the applied field (with respect to the film normal). At high fields the curves reflect the uniaxial anisotropy of the sample.

### Torque Magnetometer Specifications

#### Torque [ $\tau$ ]

Noise Floor:	$1 \cdot 10^{-9}$ N·m (high sensitivity chip) $2 \cdot 10^{-8}$ N·m (large moment chip)
Maximum Torque:	$1 \cdot 10^{-5}$ N·m (high sensitivity chip) $1 \cdot 10^{-4}$ N·m (large moment chip)

#### Physical Parameters

Chip Size:	6 mm × 6 mm × 1 mm
Available Sample Volume:	1.5 mm × 1.5 mm × 1.5 mm
Maximum Sample Weight:	10 mg

**Operational Range** 1.8 to 400 K; 0 to 16 T

\*Stated value is for a 40 second sampling time  
Specifications are subject to change without notice.

# Magnetometry

## Vibrating Sample Magnetometer (VSM)

DynaCool (D525) / PPMS (P525) VersaLab (V525)

The Vibrating Sample Magnetometer (VSM) option employs a puck-based first-order gradiometer coil set and high-resolution linear transport motor that enables the PPMS to operate as a sensitive magnetometer. The static (DC) magnetic moment of the sample can be measured as a function of temperature or field. With a typical 1 second averaging time per datum, data acquisition rates are comparatively fast. Furthermore, measurements as a function of sweeping the measurement temperature or field are possible. An included set of standard sample holders enable measurements of a wide variety of sample sizes and morphologies, such as: small single crystals, thin films (can be oriented with applied field in- or out-of film plane), sintered polycrystalline pieces, and loose powders.

### Key Features

- Lock-in measurement technique isolates sample signal from external mechanical and electronic noise for precise measurement of sample moment
- Linear transport motor enables centering accuracy within  $\pm 0.04$  mm
- A temperature sensor integrated within the coil set provides sample thermometry via exchange gas coupling
- Standard sample holders included are a low-background quartz paddle and brass half-tube with quartz spacers and polycarbonate capsules

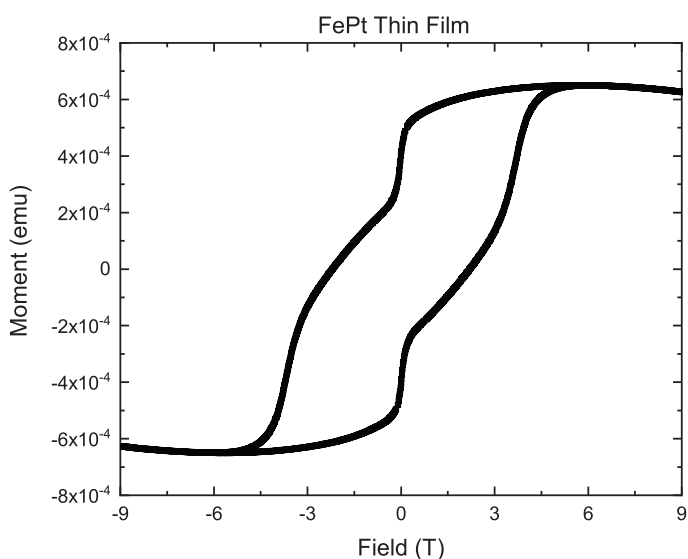

Room temperature major hysteresis loop of a high anisotropy FePt thin film with an in-plane saturation field of approximately 5 T and a coercivity of 2.2 T. Sample provided by Prof. Kai Liu, Georgetown University.

## Vibrating Sample Magnetometer Specifications

(for standard bore in zero field, unless indicated)

### Magnetic Moment [ $m$ ]

Accuracy:	$\pm 0.5\%$ , using 2.8 mm dia. $\times$ 4 mm tall cylinder (shape of included Pd reference)
Noise Floor*:	$< 6.0 \cdot 10^{-7}$ emu @ 300 K
Additional Relative Noise*:	$3.0 \cdot 10^{-7}$ emu/T or 0.5%, whichever is greater $1.0 \cdot 10^{-6}$ emu/T or 0.5%, whichever is greater (EverCool II)
Max Measurable Moment:	$m_{max}$ [emu] = 40/Peak Amplitude [mm]

### Drive Parameters

Oscillation Amplitude:	0.1 to 5 mm peak, 2 mm (typical)
Oscillation Frequency:	10 to 60 Hz, 40 Hz (typical)
Averaging Time :	0.5 to 750 seconds, 1 second (typical)

### Coil Set Dimensions

Bore Diameter:	6.3 mm
Coil Separation:	9 mm

### Operational Range

1.8 to 400 K; 0 to 16 T

\*Parameters are integration-time dependent; stated values are for integration times of 1 second at 40 Hz, 2 mm amplitude excitation. Total observed noise is the sum of the floor and relative components.

Specifications are subject to change without notice.

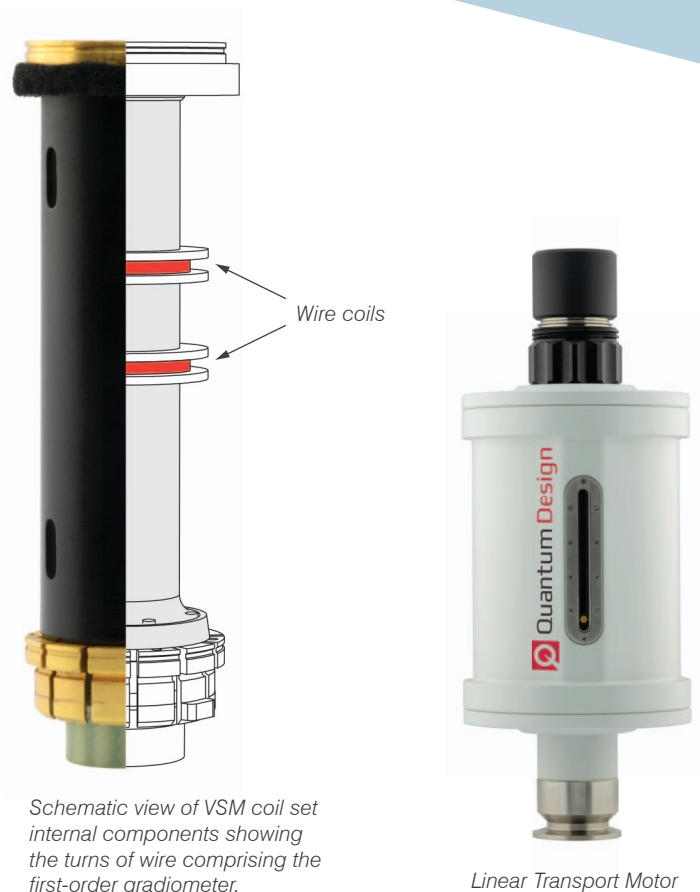

Schematic view of VSM coil set internal components showing the turns of wire comprising the first-order gradiometer.

# Magnetometry

## Large Bore Coil Set (VSM)

DynaCool (D529) / PPMS (P529) / VersaLab (V529)

The large bore coil (LBC) option extends the utility of the VSM by accommodating larger diameter sample holders (e.g., drinking straws, using the included straw adapter) and pressure cells. The static (DC) magnetic moment can still be measured both as a function of temperature or field using much of the same hardware, and an identical software interface, as the standard VSM setup.

### Key Features:

- Greater flexibility in sample mounting techniques
- Ability to use drinking straws as sample holders
- Ability to use pressure cells for magnetic measurements at pressures up to 1.3 GPa
- Operation is identical to the standard VSM option



Comparison of the standard (left) and large (right) bore diameters for the available VSM coil sets.



Various sample holders for VSM measurements. The straw holder (top) and large brass trough are only compatible with the LBC, whereas the quartz paddle, small brass trough (with polycarbonate powder holders) and quartz bracers (shown), and heater stick (for VSM Oven measurements) can all be used with the standard bore coil set.

## Large Bore Coil Set (VSM) Specifications

(for large bore in zero-field, unless indicated)

### Magnetic Moment [ $m$ ]

Accuracy:	$\pm 0.5\%$ , using 2.8 mm dia. $\times$ 4 mm tall cylinder (shape of included Pd reference)
Noise Floor*:	$< 1.5 \cdot 10^{-6}$ emu @ 300 K
Additional Relative Noise*:	$3.0 \cdot 10^{-7}$ emu/T or 0.5%, whichever is greater
Max Measurable Moment:	$m_{\max}$ [emu] = 75/Peak Amplitude [mm]

### Drive Parameters

Oscillation Amplitude:	0.1 to 5 mm peak, 2 mm (typical)
Oscillation Frequency:	10 to 60 Hz, 40 Hz (typical)
Averaging Time :	0.5 to 750 seconds, 1 second (typical)

### Coil Set Dimensions

Bore Diameter:	12 mm
Coil Separation:	12.2 mm

### Operational Range

1.8 to 400 K; 0 to 16 T

\*Parameters are integration-time dependent; stated values are for integration times of 1 second at 40 Hz, 2 mm amplitude excitation. Total observed noise is the sum of the floor and relative components.

Specifications are subject to change without notice.

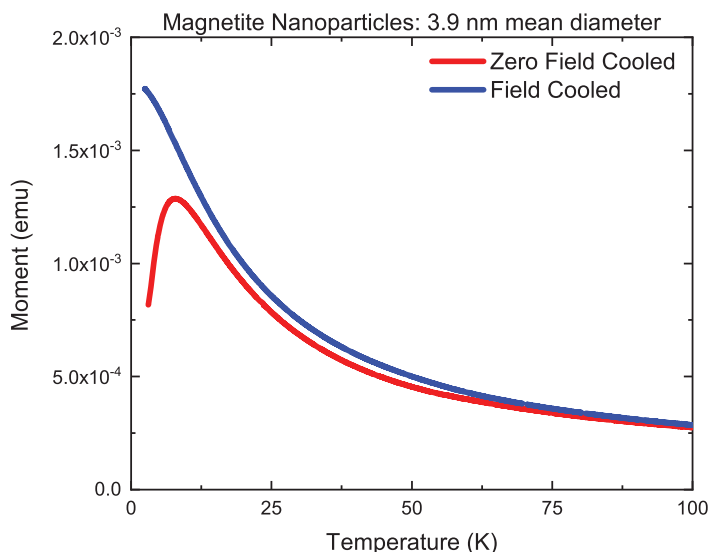

Field cooled (blue) and zero field cooled (red) curves measured in a 100 Oe field of a magnetite nanoparticle dispersion (3.9 nm mean diameter) exhibiting a blocking temperature of approximately 7 K. Sample provided by V. A. Ortíz-Vergara, M. A. Garza-Navarro, V. A. González-González Universidad Autónoma de Nuevo León, Facultad de Ingeniería Mecánica y Eléctrica.

# Magnetometry

## Vibrating Sample Magnetometer Oven

DynaCool (D527) / PPMS (P527) / VersaLab (V531)

The VSM Oven option allows the temperature range of the conventional VSM option to be extended upwards to 1000 K. This option employs the standard VSM coilset and transport motor but uses a special alumina sample holder with an integrated resistive heater and temperature sensor to locally heat and sense the sample temperature. A special sample rod and a hermetically sealed wired-access-port (WAP) provide electrical access to the oven sample holder. The nearby VSM coil set is protected by shielding the sample in a copper foil and operating in a high-vacuum environment (hi-vac capabilities are a prerequisite for the VSM oven).

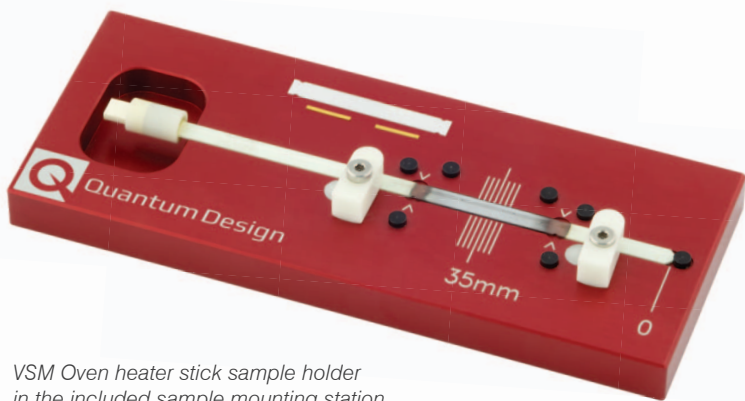

VSM Oven heater stick sample holder in the included sample mounting station (depicted discoloration is typical). Also shown are components of the optional P540 Dry Mount Kit, allowing samples to be secured without the use of the standard cement.

### Key Features:

- User kit comes standard with sample mounting high temperature Zircar cement and copper radiation shields
- Pre-mounted high purity (99.994%) nickel reference sample ( $T_C=627$  K) allows for quick verification of oven performance
- Optional dry-mounting kit allows for easy mounting of samples (e.g. thin films on substrates) without the need of cement

## VSM Oven Specifications (for zero-field, unless indicated)

### Temperature [T]

Range*:	300 to 1000 K
Ramp Rate:	Up to 1000 K/min.
Accuracy:	$\pm 2\%$ after stabilizing
Stability:	$\pm 1$ K, for fields up to 14 T

### Magnetic Moment [m]

Accuracy**:	$\pm 2\%$ or $6 \cdot 10^{-6}$ emu, whichever is greater
Noise Floor***:	$< 6.0 \cdot 10^{-6}$ emu @ 300 K
Additional Relative Noise***:	$5 \cdot 10^{-7}$ emu/T or 0.5%, whichever is greater

<b>Operational Range</b>	315 to 1000 K; 0 to 16 T
--------------------------	--------------------------

\*Please note, heater stick sample holders **cannot** be cooled below 300 K. The material becomes very brittle at colder temperatures and will likely fail.

\*\*The background signal from the heater stick sample holder is not necessarily reproducible from holder to holder, which in turn will reduce accuracy.

\*\*\*Parameters are integration-time dependent; stated values are for integration times of 1 second at 40 Hz, 2mm amplitude excitation. Total observed noise is the sum of the floor and relative components.

Specifications are subject to change without notice.

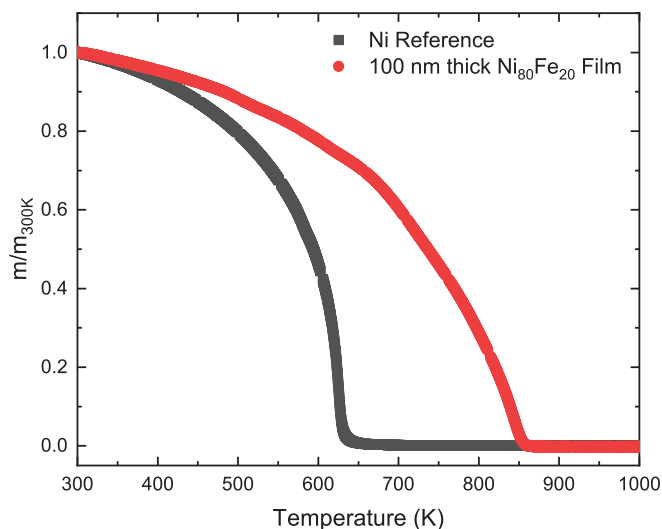

Normalized moment as a function of temperature for the included Ni reference (black) and a 100 nm thick Permalloy thin film (red) exhibiting the Curie temperature of each.

# Magnetometry

## First Order Reversal Curve (FORC) Software for VSM

DynaCool (D181) / PPMS (P181) / VersaLab (V181)

First Order Reversal Curve (FORC) measurements and their subsequent analysis provide additional insights into the magnetic reversal mechanisms of bulk, thin film, and nano-patterned samples that conventional major hysteresis loops cannot. These families of curves can provide a qualitative/quantitative fingerprint of various magnetic reversal mechanisms, as well as aid in distinguishing between reversible and irreversible switching mechanisms. Further applications of the technique include the ability to calculate reversal mechanism phase fractions along with coercivity and interaction field distributions.

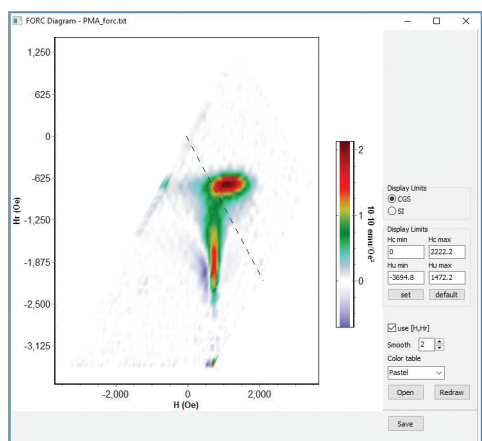

The FORC distribution of a  $[\text{Co}(0.5 \text{ nm})/\text{Pd}(1 \text{ nm})]_{10}$  film exhibiting perpendicular magnetic anisotropy is plotted in the  $(H_c, H_i)$  coordinate system. Sample provided by Prof. Kai Liu, Georgetown University.

## VSM FORC Specifications

See VSM Standard / Large Bore / Oven Specifications for Details

Operational Range 1.8 to 1000 K; 0 to 16 T

Specifications are subject to change without notice.

## Key Features:

- Fully automated FORC acquisition using MultiVu
- FORC distributions can be calculated and displayed in real-time during a measurement
- Users can change between the  $(H_c, H_i)$  and  $(H, H_i)$  coordinate systems as well as update the smoothing factor, color scheme, and measurement units on the fly
- Compatible with any Quantum Design VSM configuration including the standard and large bore coil sets and the VSM oven
- Resulting output data file is preformatted for easy import into the FORCinel post-processing software

## MultiVu User Interface

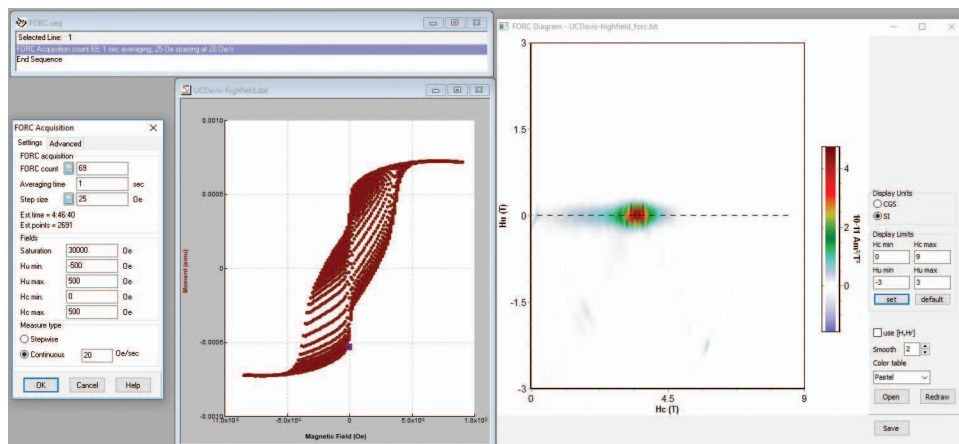

FORC measurements can be easily incorporated into standard VSM sequences. The FORC distribution of a high anisotropy FePt thin film is plotted in the  $(H_c, H_i)$  coordinate system. Sample provided by Prof. Kai Liu, Georgetown University.

# Magnetometry

## Fiber Optic Sample Holder (VSM)

DynaCool (D320) / PPMS (P320)

For samples exhibiting an evolution of their properties when subject to electromagnetic radiation, the VSM Fiber Optic Sample Holder (FOSH) enables light to be delivered to the VSM sample space during a measurement. A special sample holder, optimized either for the UV or IR ends of the spectrum, couples to a fiber optic carrying sample rod of the same material; on the other end a standard SMA-style feedthrough to the Wired Access Port can be connected to various light sources to provide the desired wavelength of radiation.

### Key Features:

- Enables VSM measurements in the presence of electromagnetic radiation
- Specialized sample rod and holder transmitting a wide spectrum and optimized to further include either UV or IR
- Standardized fiber connection ensures compatibility with a wide range of light sources

### FOSH Specifications (VSM) (for zero-field)

#### Magnetic Moment [ $m$ ]

Sensitivity:  $< 1 \cdot 10^{-4}$  emu

#### Sample Space Parameters

Maximum Length: 1.6 mm

Maximum Diameter: 1.6 mm

Transmittance:  $> 60\%$  of 325 nm to 900 nm; UV holder  
 $> 60\%$  of 375 nm to 2250 nm; IR holder

#### Operational Range

1.8 to 400 K; 0 to 16 T

Specifications are subject to change without notice.

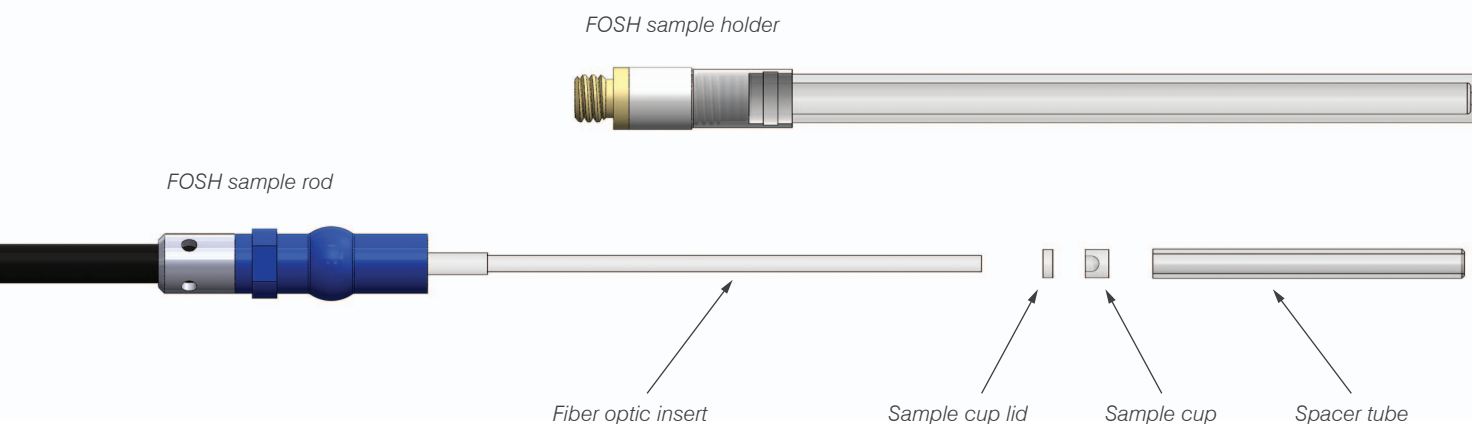

The optional TLS120Xe light source can be used to deliver light to a sample installed in the FOSH. (See page 29 for further details)



# Magnetometry

## Pressure Cell for Magnetometry

DynaCool (D421) / PPMS (P421) / VersaLab (V421)

Often a sample's magnetic properties evolve under the application of substantial hydrostatic pressure. The pressure cell option for magnetometry is manufactured by HMD, a leading Japanese supplier of pressure cells. A simplified design requires neither copper sealing rings or a hydraulic press to achieve the maximum available pressure of 1.3 GPa, while its BeCu construction affords a minimized, uniform magnetic background.

### Key Features:

- Complete kit includes required tools and materials for mounting samples, applying pressure to the cell, and measuring pressure
- Included manometer materials are tin and lead whose superconducting transition temperatures can be used to infer actual cell pressure
- BeCu construction provides minimal background signal and is also compatible with AC susceptibility measurements at suitably low frequencies



High Pressure Cell



Pressure Cell Kit

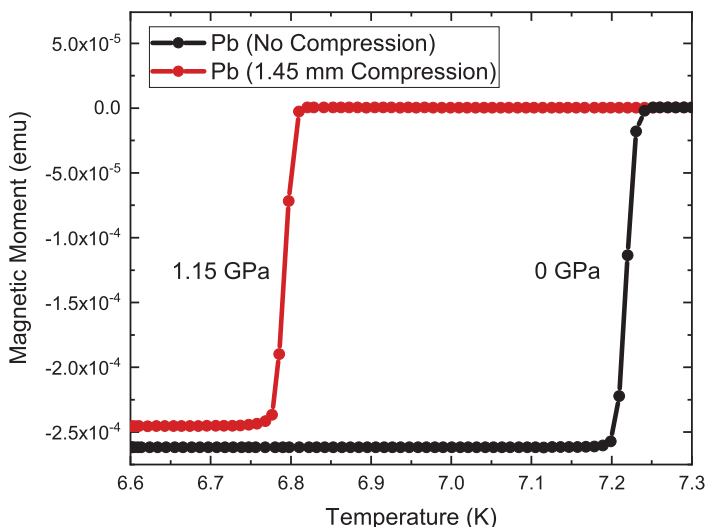

Temperature-dependent magnetization ( $H = 2$  Oe) of elemental lead (Pb) depicting the suppression of the superconducting transition with applied pressure. For a given compression length of the cell the transition temperature can be measured and the pressure calculated using an equation of state.

### High Pressure Cell (Magnetometry) Specifications

#### Pressure [P]

Maximum Sample Pressure: 1.3 GPa

#### Sample Space Parameters

Diameter: 1.7 mm, 2.2 mm  
Length: 7 mm

#### Magnetic Moment [m]

Background Signal:  $4 \cdot 10^{-7}$  emu/T

#### Operational Range

1.8 to 400 K; 0 to 16 T

Specifications are subject to change without notice.

# Magnetometry

## AC Susceptibility (ACMS II)

DynaCool (D505) / PPMS (P505) / VersaLab (V505)

The AC Measurement System (ACMS II) is a versatile susceptometer for magnetic measurements. In addition to a mutual induction-based determination of the AC susceptibility, the ACMS II enables the user to perform DC magnetization measurements without having to change sample mounts, electronics, or the hardware configuration. The coil set assembly can be used over the entire field and temperature range of the base system.

### Key Features:

- Automated nulling procedure utilizes trim coils to minimize background contributions to the measured AC susceptibility
- Multi-point background subtraction schemes available to improve AC susceptibility accuracy
- Susceptibility can be parameterized either as a total moment and phase angle  $[\chi, \theta]$  or as a real and imaginary component  $[\chi', \chi'']$
- Automated touch-down procedure preserves sample centering across large changes in temperature
- Included sample holders allow for various types of samples to be measured including: small single crystals, thin films (can be oriented with applied field in- or out-of film plane), sintered polycrystalline pieces, and loose powders

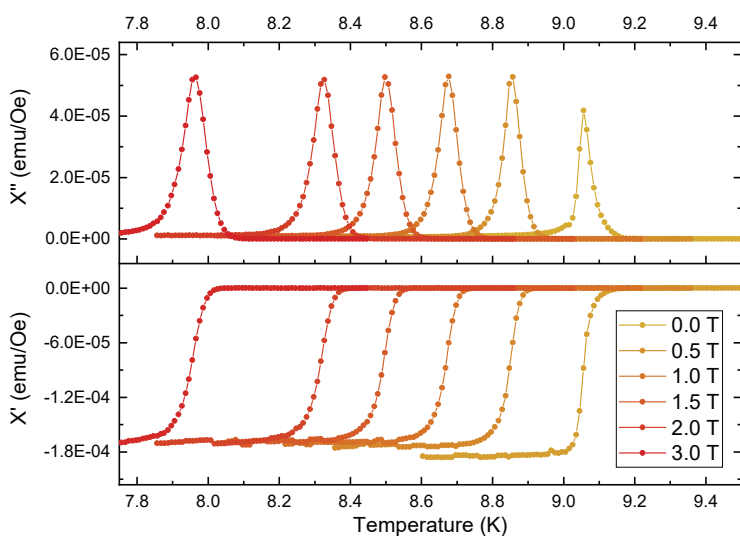

Temperature dependence curves of the real and imaginary components of AC susceptibility in a NbTi sample for a family of fixed magnetic fields. The onset of temperature of the superconducting state is suppressed lower for increasingly high field strengths.

## AC Measurement System (ACMS II) Specifications

(for zero-field)

### AC Susceptibility $[\chi]$

Sensitivity\*:  $1 \cdot 10^{-8}$  emu @ 10 kHz  
Phase Accuracy:  $\pm 0.5^\circ$

### DC Magnetic Moment $[m]$

Sensitivity:  $5 \cdot 10^{-6}$  emu  
Accuracy:  $\pm 1\%$

### Drive Parameters

Amplitude: 0.05 to 15 Oe (peak)  
Frequency Range: 10 Hz to 10 kHz

### Coil Set Dimensions

Bore Diameter: 8 mm

### Operational Range

1.8 to 400 K; 0 to 16 T

\*Expect an order of magnitude decrease in sensitivity for every order of magnitude decrease in drive frequency.

Specifications are subject to change without notice.

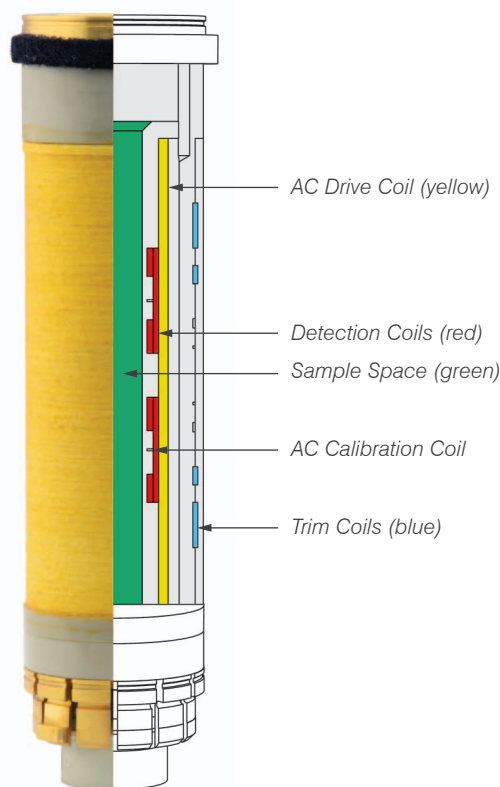

Schematic view of the ACMS-II coil set internal components showing the various individual constituent coils.

# Thermal Measurements

## Heat Capacity

DynaCool (D650) / PPMS (P650) / VersaLab (V650)

The Heat Capacity Option leverages a puck-based microcalorimeter design capable of measuring sample heat capacity across the full range of temperature and field afforded by the PPMS®. Operating in high vacuum, a sample is subjected to a thermal pulse and its temperature response is recorded as in a traditional semi-adiabatic relaxation technique. Fitting algorithms based on a model of the thermal circuit extract sample heat capacity from this curve. Typical measurements collect heat capacity as a function of temperature; measurements under a constant field are possible after using the automated field calibration function of the software.

### Key Features:

- Software-automated addenda (background) signal collection and subtraction
- Advanced fitting algorithms measure and account for finite thermal conduction between the calorimeter and sample for improved measurement accuracy
- Measurement heat pulse duration is determined by the sample time constant  $\tau$ , dynamically adapting to changes in sample heat capacity as it evolves with temperature
- Unique mounting station hardware ensures hassle-free sample mounting and minimizes the risk of damage to delicate calorimeter wiring
- Alternate slope-fitting analysis mode available in post processing for high resolution sampling of sharp first-order transitions
- Units system can be user-specified to report intrinsic properties like specific heat capacity

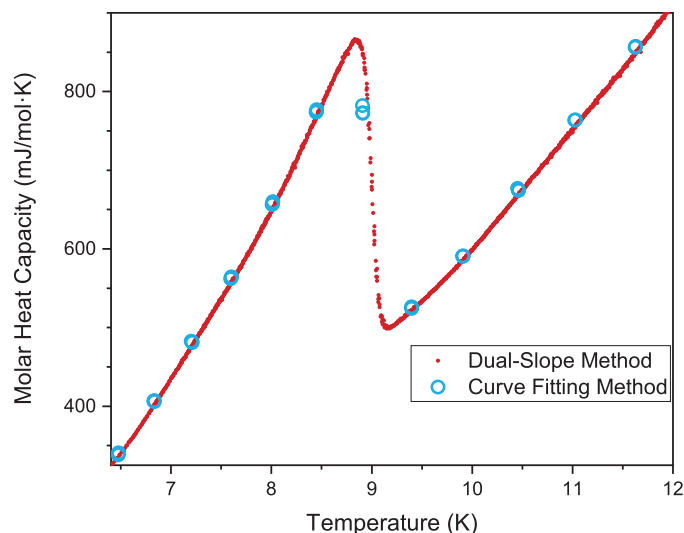

A superconducting transition is shown for a sample of NbTi alloy near 9 K. The open blue circles indicate data collected using the default curve fitting technique on a number of small heat pulses while the smaller closed red points were acquired using the slope-fitting analysis of a single large heat pulse.



Heat Capacity Puck installed in the Sample Mounting Station

Optional Vertical Puck Kit (P111), shown with Heat Capacity Frame

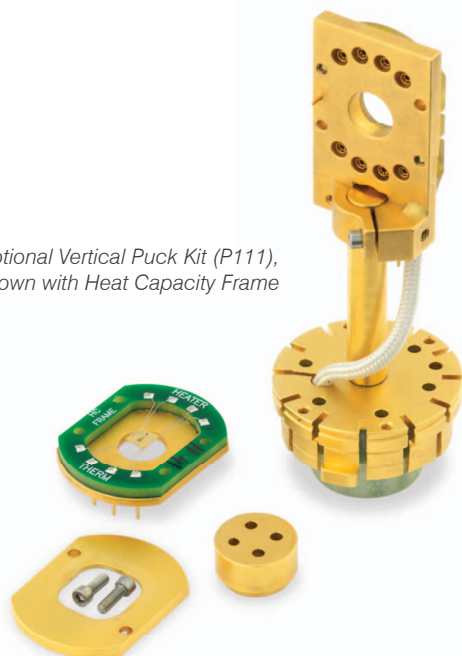

### Heat Capacity Specifications (for Zero Field)

#### Heat Capacity [ $C_p$ ]

Accuracy:  $\pm 5\%$  for 2 K to 300 K;  $\pm < 2\%$  typical  
 Resolution: 10 nJ/K @ 2 K

#### Addenda Characteristics

Calorimeter Platform Area  
 (maximum sample footprint): 3 mm  $\times$  3 mm  
 Typical Addenda Magnitude: 0.2  $\mu$ J/K @ 2 K; 15 mJ/K @ 400 K

**Operational Range** 1.8 to 400 K; 0 to 16 T

Specifications are subject to change without notice.

# Thermal Measurements

## Thermal Transport (TTO)

DynaCool (D670) / PPMS (P670) / VersaLab (V670)

Using the Thermal Transport Option (TTO) all three constituent experimental parameters of the thermoelectric figure of merit (ZT) can be measured simultaneously and continuously as a function of temperature. Operating in high vacuum, a sample is subjected to a thermal pulse and its temperature and voltage responses are recorded. Fitting algorithms based on a model of the thermal circuit extract a sample's thermal conductance and thermopower from these curves, and a resistance measurement is executed immediately after. ZT is automatically calculated as well, and can be evaluated across the full range of temperature and field afforded by the PPMS®.

### Key Features

- Simultaneously measure a sample's thermal conductivity, Seebeck coefficient, and electrical resistivity with a single sequence command
- Derived thermoelectric figure of merit and associated uncertainty is automatically calculated
- Mounting hardware included for two- or four-probe configuration to best suit a particular sample's geometry
- Adaptive measurement algorithm enables continuous data acquisition while ramping temperature, eliminating the need to repeatedly wait for stability as in traditional conductance measurements
- Raw data can be viewed for real-time diagnostics of data quality or post-processing using custom fit functions
- User kit includes specialized mounting hardware, lead material, conductive epoxy, and an extra set of heater/thermometers



*TTO Puck with Disk-Shaped Sample Installed*



*Thermal Transport Option Puck installed in the Puck Mounting Station*

# Thermal Measurements

## Thermal Transport (TTO)

DynaCool (D670) / PPMS (P670) / VersaLab (V670)

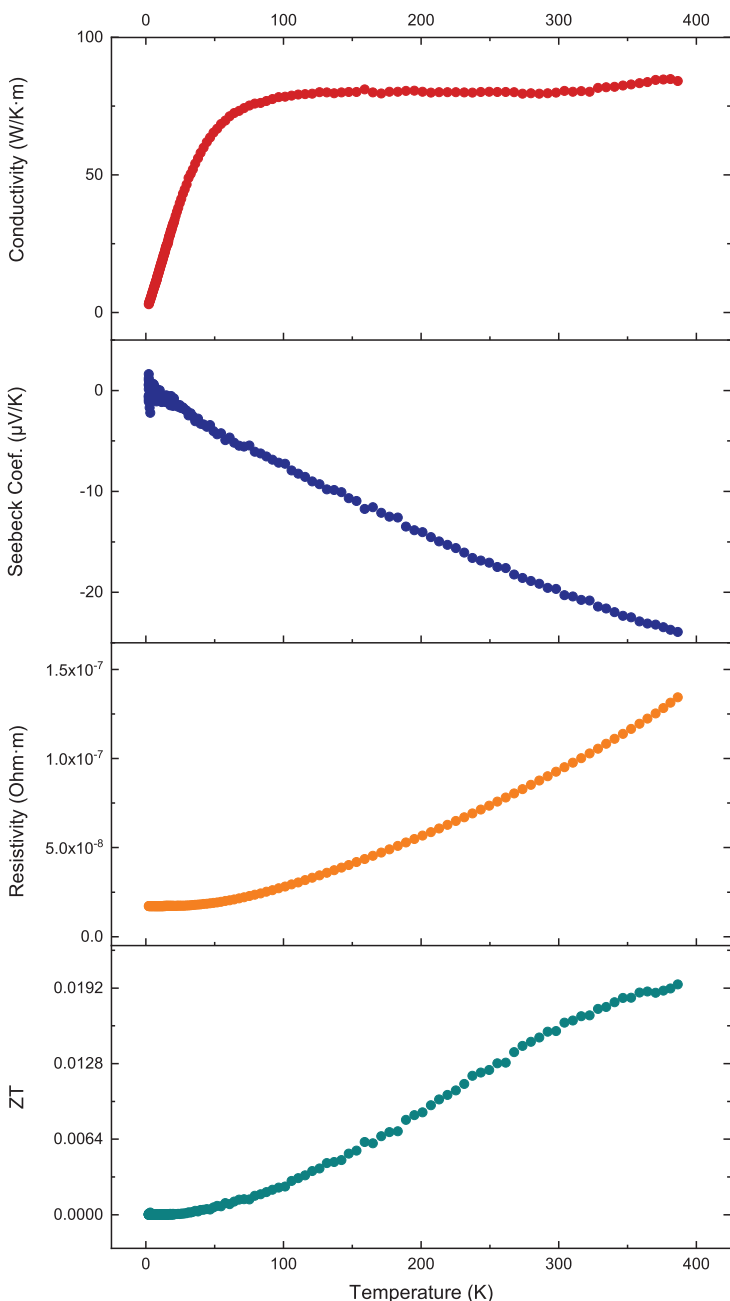

A typical response of the three properties measured by the TTO (thermal conductivity, Seebeck coefficient, electrical resistivity) are all shown, along with the calculated thermoelectric figure of merit ZT, for the nickel reference sample included with the option.

## Thermal Transport (TTO) Specifications (for zero-field)

### Thermal Conductance [K]

Typical Accuracy:  $\pm 5\%$  or  $\pm 2 \mu\text{W/K}$ , whichever is greater, for  $T < 15 \text{ K}$   
 $\pm 5\%$  or  $\pm 20 \mu\text{W/K}$ , whichever is greater, for  $15 \text{ K} < T < 200 \text{ K}$   
 $\pm 5\%$  or  $\pm 0.5 \text{ mW/K}$ , whichever is greater, for  $200 \text{ K} < T < 300 \text{ K}$   
 $\pm 5\%$  or  $\pm 1 \text{ mW/K}$ , whichever is greater, for  $T > 300 \text{ K}$

Estimated Dynamic Range\*:  
 1 to 25 mW/K for high  $T = 400 \text{ K}$   
 100  $\mu\text{W/K}$  to 100 mW/K for  $T \approx 50 \text{ K}$   
 10  $\mu\text{W/K}$  to 1 mW/K for  $T \approx 1.9 \text{ K}$

### Thermal Conductivity [ $\kappa = K \cdot (L/A)$ ]

Estimated Dynamic Range\*: 0.1 to 250 W/m·K @  $T = 300 \text{ K}$

### Seebeck Coefficient [S]

Typical Accuracy: Error in  $S = \pm 5\%$  or,  
 Error in  $S = \pm 0.5 \mu\text{V/K}$  or,  
 Error in  $V = \pm 2 \mu\text{V}$ , whichever is greatest

Estimated Dynamic Range\*: 1  $\mu\text{V/K}$  to 1 V/K

### Resistivity [ $\rho = R \cdot (A/L)$ ]

Typical Precision: 0.01% for 1  $\Omega$  @ 200  $\mu\text{A}$   
 Estimated Dynamic Range\*: 10  $\mu\Omega$  to 5 M $\Omega$

### Thermoelectric Figure of Merit [ $ZT = T \cdot S^2 / (\kappa \cdot \rho)$ ]

Typical Accuracy:  $\pm 15\%$   
 (Assumes  $\pm 5\%$  accuracy of  $K$  and  $S$  and negligible contributions from  $T$ ,  $\rho$ )

### Speed of Acquisition

Typical Temperature Slew Rates:  $\pm 0.5 \text{ K/min}$ ,  $T > 20 \text{ K}$   
 $\pm 0.2 \text{ K/min}$ ,  $T < 20 \text{ K}$

### Operational Range

1.8 to 400 K; 0 to 16 T\*\*

\*Range estimates can depend significantly on an individual sample's aspect ratio and heat capacity.

\*\*Measuring under both applied magnetic fields greater than  $H = 0.1 \text{ T}$  and temperatures below  $T = 20 \text{ K}$  may require additional corrections due to the temperature sensors' intrinsic magnetoresistance.

Specifications subject to change without notice.

# Thermal Measurements

## Dilatometer

DynaCool (D680) / PPMS (P680)

For quantifying a sample's thermal expansion coefficient or probing magnetostriction effects, the Dilatometer offers unparalleled resolution and convenience. The dilation is determined by rigidly coupling a sample's expansion/contraction to the distance between the plates of a capacitor. Further, a ratiometric voltage measurement renders a large costly absolute capacitance bridge unnecessary, while the fused-silica cell design requires no first-order corrections due to adsorbed gas, thermal gradients, or applied magnetic field.

### Key Features

- Lapping tools for sizing samples to the ideal width (2 mm) included along with measurement electronics, probe, and cell hardware
- Provided balance meter allows users to confirm proper sample sizing by a direct measurement before hardware is installed in the PPMS
- Manual rotation (rotation axis normal to the direction of applied field) of the sample within the cell between  $-20^\circ$  and  $+110^\circ$  outside of the PPMS enables systematic anisotropy studies
- Fused silica and copper reference samples included for periodic verification of system performance

### Dilatometer Specifications (for zero-field)

#### Dilation [ $\Delta L$ ]

Resolution:	< 10 pm, @ 2 K
Noise Floor:	< 20 pm, @ 2 K
$\Delta L/L$ Resolution:	$10^{-9}$ , for 2 mm wide sample
Background Dilation:	< 250 nm (300 $\rightarrow$ 2 K) < 300 pm (0 $\rightarrow$ 9 T), @ 2 K

#### Sample Space Parameters

Ideal Sample Size\*:  $2 \pm 0.05$  mm  $\times$  2.5 mm  $\times$  3 mm

#### Operational Range

1.8 to 400 K; 0 to 16 T

\*For samples narrower than 2 mm, included shims can be used; other dimensions are not tightly constrained.

Specifications are subject to change without notice.



Dilatometer Capsule installed in the Balance Meter

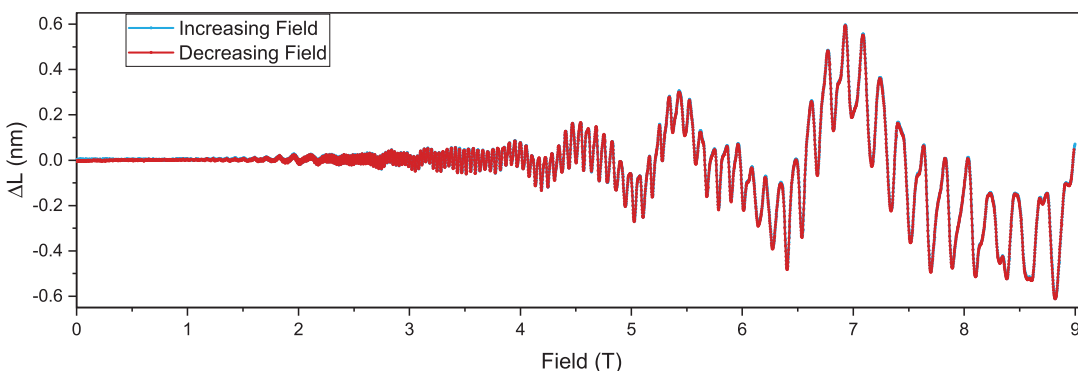

The change in length of a 2 mm long aluminum piece at 2 K is shown as a function of applied magnetic field; oscillations in dilation due to the de Haas-van Alphen effect can clearly be seen. The blue curve reflects data taken upon increasing the applied field, while the red curve corresponds to the subsequent decreasing of the field. In the 12 hours it took to collect the data, the total drift was on the order of only 10 pm (hence the red curve largely obscuring the blue).

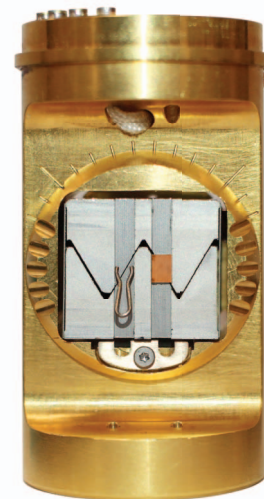

Dilatometer Capsule with copper sample

# Sub-Kelvin Capabilities

## Adiabatic Demagnetization Refrigerator (ADR)

DynaCool (D810) / PPMS (P810)

For basic transport experiments not requiring applied magnetic field, the base temperature of the PPMS® can easily be extended as low as to 100 mK using the Adiabatic Demagnetization Refrigerator (ADR). This option includes a specialized puck which integrates a sealed capsule of paramagnetic salts. After the puck is cooled to the base temperature of the PPMS (1.9 K) a magnetic field (3 T) is applied and the system pumped to a high-vacuum state. Quickly turning the field off allows the magnetic entropy of the salt to increase, which in turn rapidly cools the sample platform to 100 mK. Measurements can then be collected as the temperature slowly rises back to the PPMS base.

### Key Features:

- Extends zero-field transport measurements (ETO/Resistivity) down to 100 mK
- Allows for more than 2 hours of measurement time below typical PPMS base temperature
- Two 4-probe channels available for increased sample throughput
- Permanently sealed chamber of paramagnetic salts does not require replacing for the lifetime of the option

## ADR Specifications

### Accessible Temperatures

Range: 150 mK to 300 K  
(100 mK base typical)

### Accessible Temperatures

Time to ADR Base Temperature from 300 K: 3 hours  
Time from 0.1 to 1.9 K (Uncontrolled Drift): 2 hours (typical)

### Operational Range

0.1 to 2 K; 0 T

Specifications are subject to change without notice.



Included user kit for the ADR with additional transport pucks and a USB drive with archived thermometry calibration files.

ADR with transport puck installed

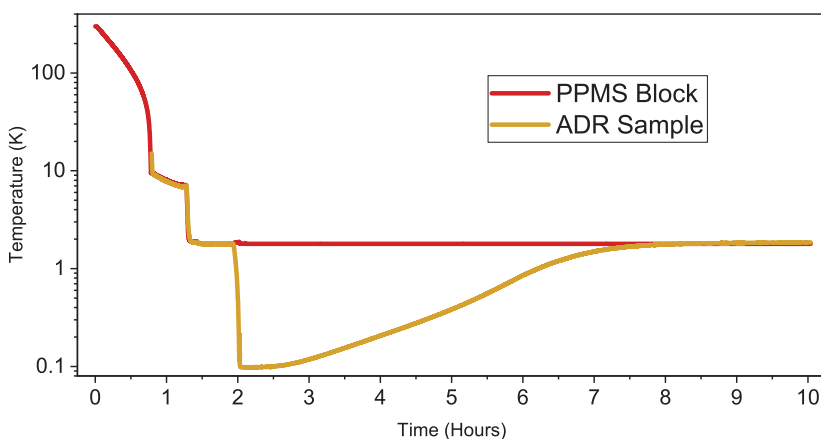

Example log of an ADR cooldown, starting from room temperature. In this case, base temperature is reached in just over two hours and the uncontrolled drift back to the PPMS block temperature lasts roughly six hours.

# Sub-Kelvin Capabilities

## Helium-3 Refrigerator

DynaCool (D825A/V) / PPMS (P825A/V)

The Helium-3 refrigerator insert reduces the ultimate base temperature achievable in the PPMS® to 0.4 K so a full four decades in temperature are accessible for compatible measurements. Software-automated gas handling of a variety of specialized cooling modes enables fast and responsive control across the available temperature range with no need for any additional user intervention. Continuous operation is possible down to 0.5 K with optional 'one-shot' operation to achieve temperatures as low as 0.35 K.

### Key Features

- Software user interface for temperature control is identical to that of the base PPMS, as are sequence commands – all gas handling operations are fully automated
- Closed-cycle gas handling loop pre-filled with  $^3\text{He}$  gas
- Automated maintenance wizards for storing and cleaning cooling mixture to maintain system performance
- Vertical (825V) and horizontal (825A) sample mount configurations available
- Compatible measurement options: AC/DC electrical transport, heat capacity

Helium-3 Refrigerator probe mounted in the integrated gas-handling cart



Helium-3 Refrigerator is available either with a horizontal sample stage (left) or a vertical sample stage (right)

### Helium-3 Refrigerator Specifications

#### Temperature Control

Range*:	< 0.4 K (0.35 K typical) to 350 K
Accuracy**:	$\pm 1\%$
Stability:	$\pm 0.2\%$

#### Operational Capabilities

Cooling Power:	6 $\mu\text{W}$ at sample stage at 0.5 K 80 $\mu\text{W}$ at sample stage at 1.0 K
Cool Down Time (300 to 0.5 K):	Less than 3 hours; 2 hours typical

#### Operational Range

0.4 to 350 K; 0 to 16 T

\*Indefinite continuous operation limited to a base of 0.5 K; temperatures below 0.4 K achievable for up to 60 minutes at a time using 'one-shot' mode.

\*\*Quoted up to the maximum field of the PPMS.

Specifications are subject to change without notice.

# Sub-Kelvin Capabilities

## Dilution Refrigerator

DynaCool (D850) / PPMS (P850)\*

The dilution refrigerator insert for the PPMS<sup>®</sup> enables access to a temperature range spanning 4 K all the way down to 50 mK for a number of compatible measurement options and custom user experiments. Software-automated gas handling of both evaporative and dilution cooling modes enables fast and responsive control across three decades of temperature and enables access to the lowest base temperature possible in a PPMS.

### Key Features

- Software user interface for temperature control is identical to that of the base PPMS, as are sequence commands – all gas handling operations for dilution and evaporative cooling modes are fully automated
- Closed-cycle gas handling loop pre-filled with proper <sup>3</sup>He/<sup>4</sup>He mixture ratio
- Automated maintenance wizards for storing and cleaning cooling mixture to maintain system performance
- Compatible measurement options: AC/DC electrical transport, heat capacity, AC susceptibility

*Zero-field heat capacity data depicting the superconducting transition in  $Ir_{0.8}Ru_{0.2}$  occurring near the base temperature of the Dilution Refrigerator. Sample provided by Milton S. Torikachvili of San Diego State University.*

## Dilution Refrigerator Specifications

### Temperature Control

Range: 50 mK to 4 K  
Accuracy\*:  $\pm 10\%$ , for T = 50 mK  
 $\pm 2\%$ , for T = 300 mK  
 $\pm 1\%$ , for T = 4 K  
Stability:  $\pm 0.2\%$  or better

### Operational Capabilities

Cooling Power: 0.25  $\mu$ W at sample stage at 100 mK  
Cool Down Time (300 K to 50 mK): Less than 8 hours; 5 hours typical  
Space for User Experiments: 0.88" (22 mm) diameter by 1.4" (35 mm) long cylindrical volume

### Operational Range:

0.05 to 4 K; 0 to 16 T

\*Quoted up to the maximum field of the PPMS.

Specifications are subject to change without notice.

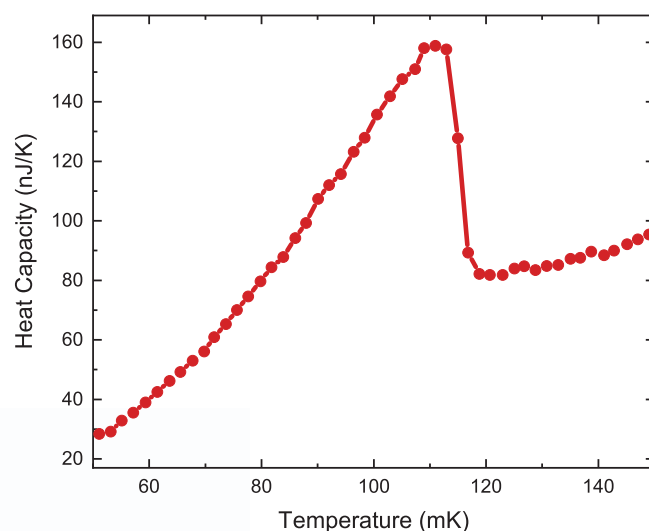

*Dilution Refrigerator with Transport Puck*

# Sub-Kelvin Measurements

Several existing PPMS® measurement options have been adapted to operate at sub-Kelvin temperatures in the various refrigerators offered. In some cases, additional hardware and/or electronics may be required for full compatibility, and the associated specifications are modified accordingly.

## AC Resistance, DC Resistance [ADR, Helium-3, DR]

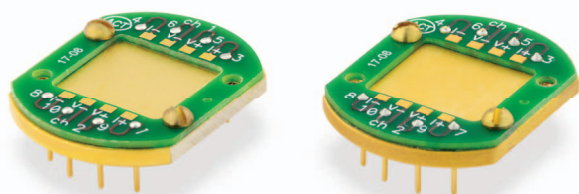

DR (left) and Helium-3 (right) Transport Pucks for use with either Resistivity or ETO

## Sub-Kelvin Measurements Specifications (for Zero Field)

### AC Resistance, DC Resistance [ADR, Helium-3, DR]

Identical to standard specifications except:

Current Amplitude Range: Maximum available current may be further limited by sample resistance and available cooling power, or desired drift rate in the case of the ADR.

Operational Range: 0.1 to 2 K; 0 T (ADR)  
0.4 to 350 K; 0 to 16 T (<sup>3</sup>He)  
0.05 to 4 K; 0 to 16 T (DR)

### Heat Capacity [Helium-3, DR]

Identical to standard specifications except:

Typical Addenda Magnitude: 2.5 nJ/K @ 0.05 K, 225 nJ/K @ 2 K, 1.5 μJ/K @ 4 K; (DR)  
10 nJ/K @ 0.4 K, 2.25 μJ/K @ 4 K, 340 μJ/K @ 35 K, 11 mJ/K @ 350 K; (<sup>3</sup>He)

Operational Range: 0.4 to 350 K; 0 to 16 T (<sup>3</sup>He)  
0.05 to 4 K; 0 to 16 T (DR)

Specifications are subject to change without notice.

## Heat Capacity [Helium-3, DR]

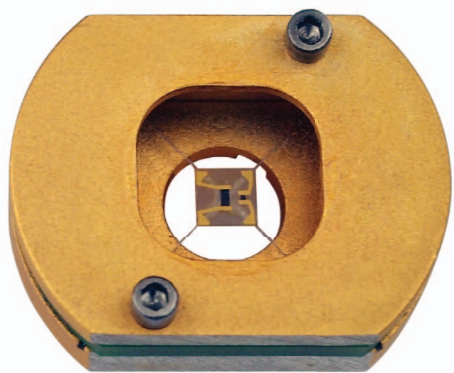

Dilution Refrigerator / Helium-3 2D Heat Capacity Puck

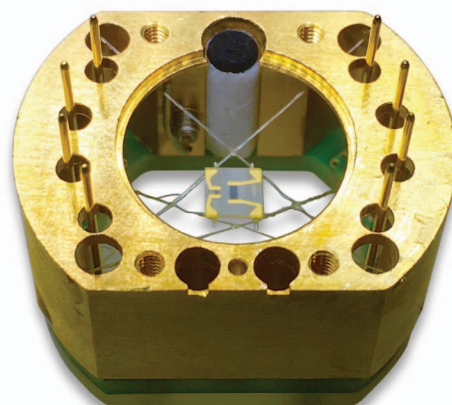

Dilution Refrigerator 3D Heat Capacity Puck (DynaCool only)

# Sub-Kelvin Measurements

## AC Susceptibility [DR]

The AC Susceptibility Option for the Dilution Refrigerator (AC DR) brings the easy usability of the ACMS II option into the milli-Kelvin temperature range. Thermally anchoring the coil set to the puck interface rather than the DR sample stage, and using superconducting wires for the drive coils, lead to virtually no heat load on the DR. This allows for a mutual induction-based determination of the AC susceptibility of samples for frequencies between 10 Hz and 10 kHz down to 50 mK.

## Sub-Kelvin Measurements Specifications (for Zero Field)

### AC DR [DR]

#### AC Susceptibility [ $\chi$ ]

Sensitivity\*:  $5 \cdot 10^{-7}$  emu @ 10 kHz  
Phase Accuracy:  $\pm 2^\circ$

#### Drive Parameters

Drive Amplitude: 2 mOe to 3 Oe (peak)  
Frequency Range: 10 Hz to 10 kHz  
Operational Range: 0.05 to 4 K; 0 to 12 T

\*Expect an order of magnitude decrease in sensitivity for every order of magnitude decrease in drive frequency.

Specifications are subject to change without notice.

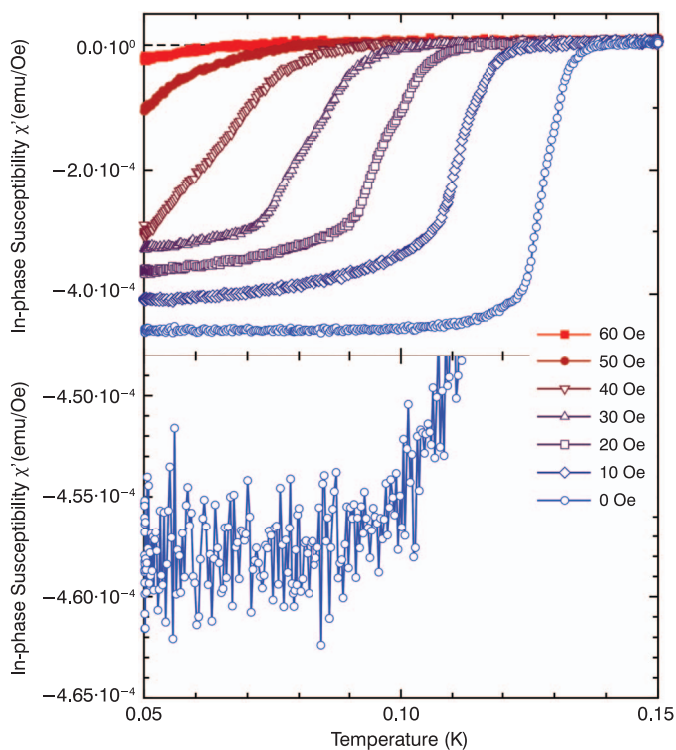

*In-phase susceptibility for the superconducting transition of an  $Ir_{0.8}Ru_{0.2}$  sample measured using an AC excitation of 10 mOe and a frequency of 10 kHz for various DC background fields. The lower graph highlights the noise level for the zero field data. The peak to peak scatter of the data is about  $5 \times 10^{-6}$  emu/Oe, corresponding to  $5 \times 10^{-8}$  emu in absolute signal.*

*Sample provided by Milton S. Torikachvili of San Diego State University.*



DR Probe with AC DR Sapphire Sample Stage



AC DR Coil Set

# Multi-Function Probes

Developed for users desiring to leverage the sample environment of a PPMS® for their own custom experiments, the Multi-Function Probe (MFP) provides a compatible basic probe framework for further additions and specialization. All types allow access to the sample space by customizing the top-plate, include baffles to prevent heat originating at the top of the probe from propagating to the isothermal region, and some variants enable connection to the 12-pin socket at the base of the sample chamber.

## Relevant Application Notes

- ESD-sensitive probe (1070-212)
- Photoconductivity probe (1084-752)
- Microwave Resonator / EPR (1084-750)

## Specifications

Operational Range: 1.8\* to 400 K; 0 to 16 T

\*Base temperature as delivered, before modification. The minimum temperature of the CryoFMR probe depends upon the modulation amplitude and RF frequency/power.

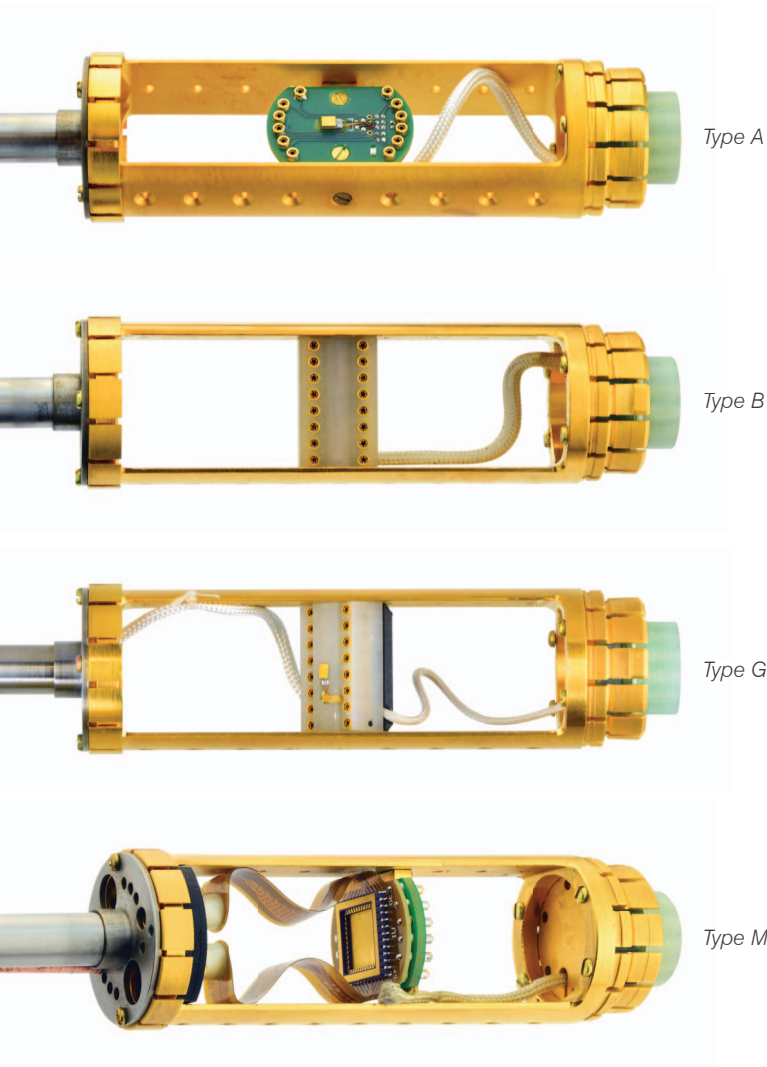

## Available MFP Types

DynaCool (D450A/B/C/G/M) / PPMS (P450A/B/C/G/M)  
VersaLab (V450A/B/C/G/M):

- **“A” Type:** includes a wired socket already connected to the 12-pin puck interface which has integrated thermometry and accepts standard QD sample mounting boards. The socket can be placed at various heights in the bottom fixture and also can be manually rotated when the probe is out of the PPMS.
- **“B” Type:** includes a wired 16-pin DIP-type socket connected to the 12-pin puck interface.
- **“C” Type:** only includes the probe body with no transfer case at the bottom end. *(Pictured on page 26)*
- **“G” Type:** for use with a removeable DIP chip carrier with use of all 16 DIP connections. Includes integrated thermometry.
- **“M” Type:** for use with a removeable chip carrier/flex-cable ribbon assembly; allows for up to 48 connections to be carried down to the sample space. Includes integrated thermometry. Both 48-pin chip carrier assembly and 20-pin LCC socket assembly available.

DynaCool (D886A/B) / (P886A/B) / (V886A/B):

- **CryoFMR:** Modified A-Type that includes Helmholtz coils for low-frequency AC fields and cryo-coaxial cables suitable for RF signals up to 40 GHz. Specialized waveguides orient thin-film samples parallel or perpendicular to the applied field. *(Pictured on page 29)*

DynaCool (D790A/B) / PPMS (P790A/B):

- **Photoconductivity Variant:** modified A-Type including one (or optionally, two) 1 mm core diameter optical fibers running down to the sample for illumination and/or spectroscopy.

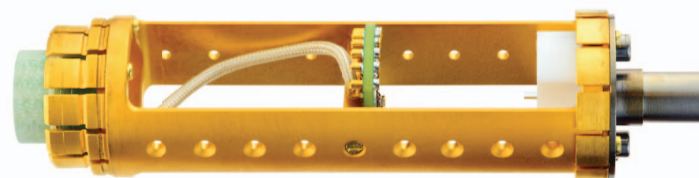

Photoconductivity

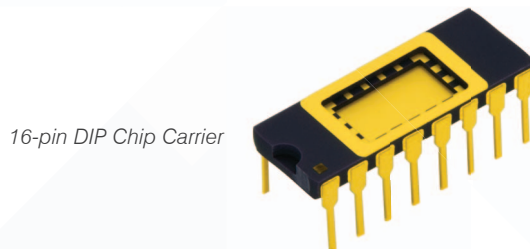

16-pin DIP Chip Carrier

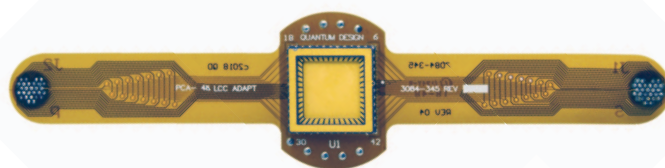

48-pin Chip Carrier Assembly

# Multi-Function Probes



Type C:  
Top-plate construction is common to all MFPs (though some have additional modifications not pictured here).

## Test Stations and Breakout Boxes

When performing diagnostic testing or integrating external electronics, having convenient access to electrical connections is crucial. These boxes enable users to easily perform continuity checks, permute connection routings, and even help protect sensitive samples.

### Test Station – Puck

Enables access to all 12 connections on a standard PPMS-compatible puck. Integrated standard 14-pin LEMO connector allows for interface with option electronics for benchtop testing.



### Breakout Box – Banana

Interfaces with the standard 14-pin LEMO, including both a plug and socket. This allows the box to be inserted inline for permutation of connections between the cryostat and electronics.



### Breakout Box – BNC

Interfaces the 16-pin Fischer connector used on Types M, G MFPs to individual BNC connectors. Integrated throw switches allow each conductor to be routed to a BUS BNC, or a ground terminal.



### Test Station – Chip Carrier

Enables access to all connections (up to 48) on the family of flex-circuit sample holders for the Type M MFP.

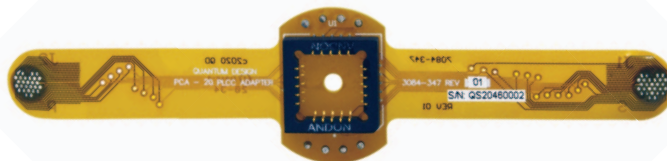

20-pin LCC  
Chip Carrier/Socket Combo

# Multi-Function Probes

## Optical Multi-Function Probe (OMFP)

DynaCool (D725A/B) / PPMS (P725A/B) / VersaLab (V725A/B)

The Optical Multi-Function Probe (OMFP) offers unprecedented versatility in affording the user optical access to experiments within the variable temperature and magnetic field environment of the PPMS® family of instruments. At the top of the OMFP, a wired access port (WAP) features an axial optical port window for free-beam experiments in the cryostat. The WAP also features modular feedthrough connectors that can be configured to allow electrical signals or fiber access to the sample space. Adjustable optical mounts can be placed along the length of the probe to position filters, relay lenses, objectives, or other elements. The capsule at the bottom contains a three-axis piezo stack allowing the in-plane position to be adjusted, and for the sample to be moved into the proper focal plane. Integrated thermometry supplies temperature readings as close to the sample as possible for accurate mapping of temperature-dependent phenomena.

### Key Features:

- Customizable 1" (SM1) free-beam access port and internal 1/2" (SM05) mounts along the optical path
- Eight contacts (2 sets of 4) available on a removable PCB sample platform for electrical measurements using existing QD transport options or external electronics
- Optional variation (725B) includes eight additional electrical feedthroughs at the sample location, accessible externally via the WAP
- Optical camera allows for fine alignment and focus *in situ*
- XYZ piezo-positioning system enables multiple samples or regions of interest to be investigated
- Complete integration of imaging and positioning with MultiVu software sequence commands

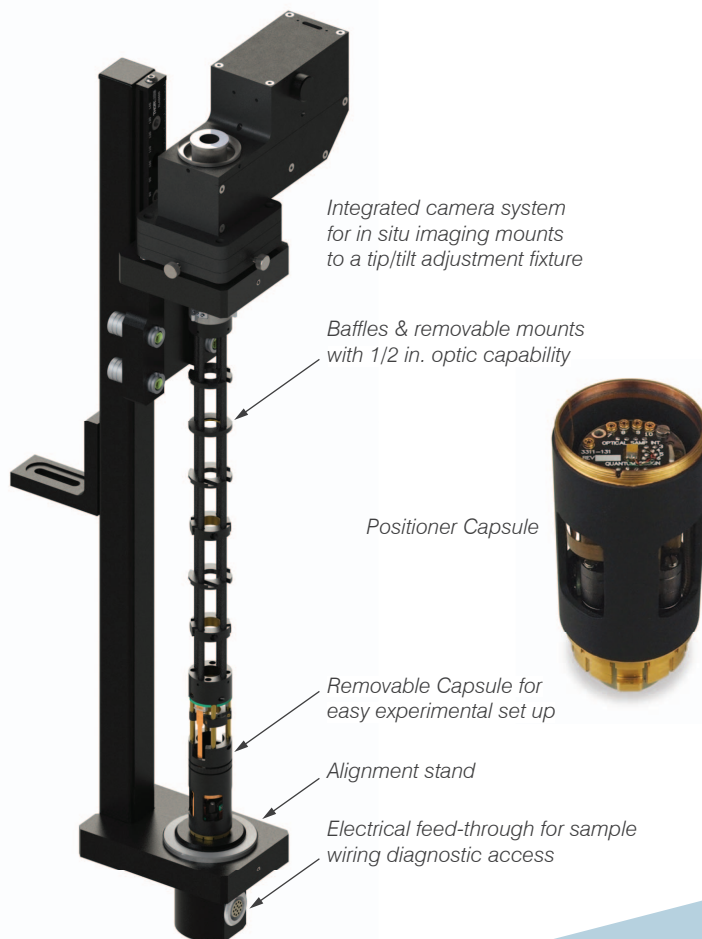
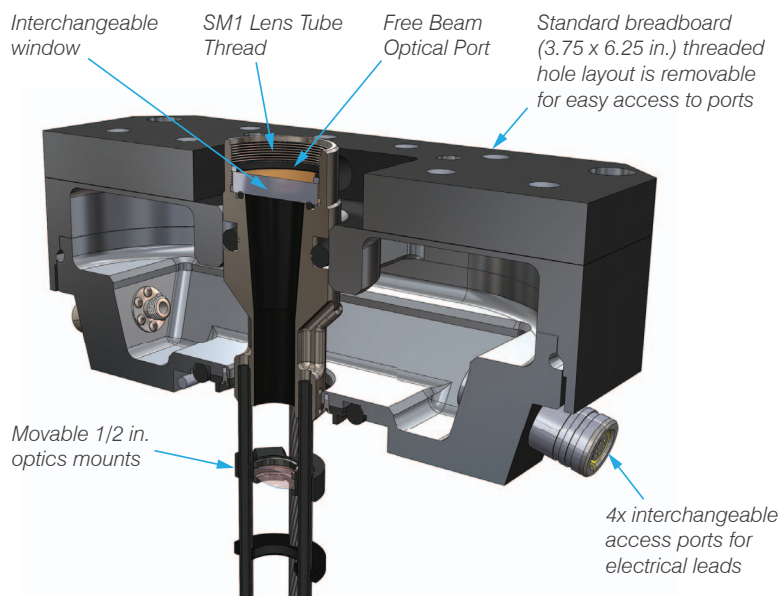

### Optical Multi-Function Probe Specifications

#### Temperature [T]

Range\*: 350 to 5 K (DynaCool, PPMS)  
350 to 50 K (VersaLab)

#### Axial Optical Window

Coupling Type: SM1 (1" diameter)  
Included Coatings: 350 to 700 nm, and 650 to 1050 nm

Camera Resolution: < 5  $\mu\text{m}^{**}$

#### Piezo-Positioner Stack

Maximum Travel: 3 mm (all axes)  
Step Size\*\*\*: 1  $\mu\text{m}$  to 1 mm (approx.; user-controlled)  
Control Mode\*\*\*: Open Loop

Operational Range: 0 to 16 T

\*Base temperature of 5 K represents the minimum achievable stable temperature under 10 mW of radiant flux.

\*\*Based on resolving individual lines within group 6, element 6 of the 1951 USAF resolution test chart.

\*\*\*Due to hysteretic effects intrinsic to the piezo-resistive drive elements and open loop operation, precise step sizes may not be repeatable between different temperatures, upon changing drive direction, or at the extreme points of the available range.

Specifications are subject to change without notice.

# Light Sources

DynaCool (D312, D326) / PPMS (P312, P326) / VersaLab (V312, V326)

## TLS120Xe and MLS Xenon Light Source

Quantum Design provides light sources for sample illumination which are an ideal complement to either the VSM FOSH or Photoconductivity MFP. The MLS Xenon Light Source produces white light which can be filtered down to a specific wavelength using a manually rotated filter wheel, while the TLS120Xe can be tuned automatically with software commands in MultiVu across an even wider range. Both sources output to a standard SMA-style connector and have user-replaceable lamps.

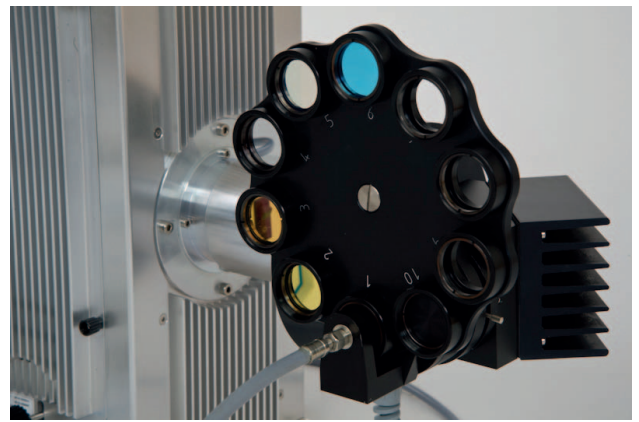

MLS Xenon Light Source shown with the 10-position filter wheel used to produce monochromatic light.



TLS120Xe with manual front panel controls active.

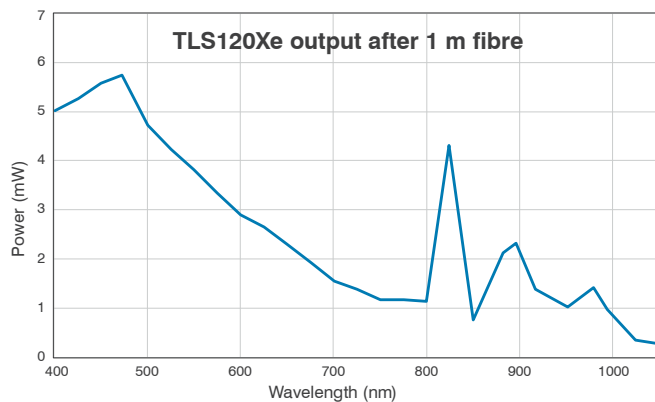

Typical power spectrum of the TLS120Xe denoting approximate radiant flux incident on a sample as a function of wavelength.

## Light Sources Specifications

### TLS120Xe

Wavelength Range:	280 to 1100 nm
Bandwidth:	20 nm (FWHM)
Grating Line Density:	1200
Nominal Blaze Wavelength:	380 nm
Lamp Type:	Short-arc OFR xenon (100 W)
Lamp Lifetime:	500 hours

### MLS Xenon Light Source

Wavelengths (FWHM):	436 nm (20 nm)
	470 nm (40 nm)
	500 nm (20 nm)
	530 nm (30 nm)
	555 nm (20 nm)
	585 nm (40 nm)
	640 nm (30 nm)
	740 nm (40 nm)
	850 nm (40 nm)
Lamp Type:	Short-arc xenon (300 W)

Specifications are subject to change without notice.

# Broadband Ferromagnetic Resonance

## CryoFMR

DynaCool (D725A/B) / PPMS (P725A/B) / VersaLab (V725A/B)

The NanoOsc Instruments AB line of broadband ferromagnetic resonance (FMR) spectrometers and coplanar waveguides (CPWs) offer a simple turn-key solution to the burgeoning field of magnetodynamics research. Broadband FMR spectroscopy allows for measurements continuously spanning several 10's of GHz. Measurements over a wide frequency range allow for significant improvements in accurately extracting a variety of material parameters not accessible by static measurement techniques.

Broadband FMR is particularly well-suited for studying magnetic thin films, which not only form the backbone of fundamental spintronics and magnonics research but are also constituents of current and future technologies focused on magnetic memories, sensors, logic, and microwave signal processing.



### Software makes FMR Easy:

The software user interface is divided into three tabs:

1. Setting up the measurement sweeps
2. Monitoring the running measurements
3. Post-processing and parameter extraction

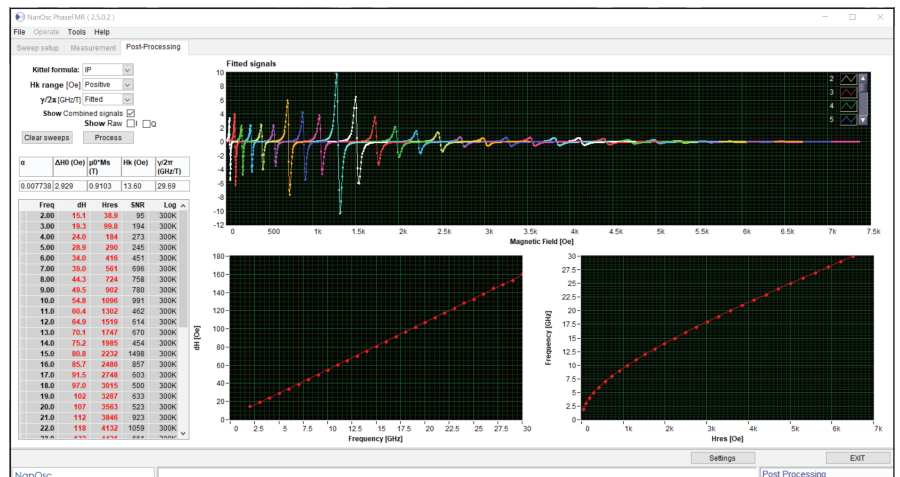

## CryoFMR Specifications

**Bandwidth** 2-8,-18, -40 GHz  
**Operational Range** 5\* to 400 K; 0 to 16 T

\*Minimum temperature dependent upon modulation amplitude and RF frequency.  
 Specifications are subject to change without notice.

### CryoFMR Probe Insert

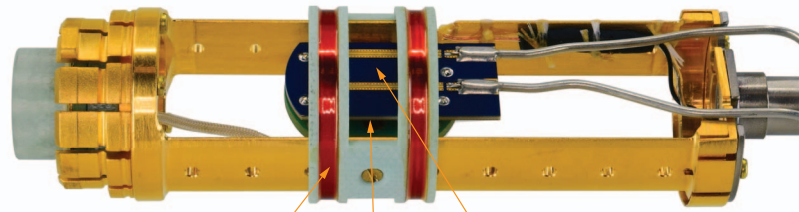

Helmholtz coils for field modulation      Temperature sensor      CPW for in-plane analysis\*\*

Standalone CryoFMR probe can be purchased separately.  
 \*\*out-of-plane CPW also included.

### Key Features:

- Turn-key FMR spectrometer with easy to use software interface
- Broadband FMR using a coplanar waveguide
- Calculates the Effective magnetization ( $M_{eff}$ ), anisotropy ( $K$ ), gyromagnetic ratio ( $\gamma$ ), damping ( $\alpha$ ), inhomogeneous broadening ( $\Delta H_0$ )
- Enables the user to extract the exchange stiffness ( $A$ ) and inverse spin Hall effect ISHE

## Compatibility Table

	DynaCool	PPMS	VersaLab
AC Resistance (ETO)	D605	P605 [Req. Model 1000]	V605
DC Resistance	D400A [Incl. D415]	P400A	V400 [Incl. V415]
Pressure Cell (Transport)	D420 [Req. D605 or D400A]	P420 [Req. P605 or P400A]	V420 [Req. V605 or V400]
Rotator	D310A/B [Incl. D415]	P310A/B	V310A/B [Incl. V415]
VSM	D525	P525 [Incl. Model 1000, Req. P945]	V525
VSM Large Bore	D529 [Req. D525]	P529 [Req. P525]	V529 [Req. V525]
VSM Oven	D527 [Req. D525]	P527 [Req. P525, P640]	V527 [Req. V525]
FORC Software	D181 [Req. D525]	P181 [Req. P525]	V181 [Req. V525]
FOSH	D320 UV/IR [Req. D525]	P320 UV/IR [Req. P525]	
Pressure Cell (Magnetometry)	D421 [Req. D525]	P421 [Req. P525]	V421 [Req. V525]
Torque Magnetometer	D550 [Req. D310]	P550 [Req. P400A, P310]	V550 [Req. V310]
ACMS II	D505A [Req. D525]	P505A [Req. P525]	V505A [Req. V525]
Thermal Transport	D670	P670 [Req. Model 1000, P640]	V670
Heat Capacity	D650	P650C [Req. Model 1000, P640]	V650
Dilatometer	D680	P680 [Req. Model 1000]	
Adiabatic Demagnetization Refrigerator	D810 [Req. D605 or D400A]	P810 [Req. P640, P605 or P400A]	
Helium-3 Refrigerator	D825A/AV	P825C/CV [Req. Model 1000, P640]	
Dilution Refrigerator	D850A	P850A [Req. Model 1000, P640]	
MFP Types A/G/M	D450A/G/M [Req. D415]	P450A/G/M	V450A/G/M [Req. V415]
MFP Types B/C	D450B/C	P450B/C	V450B/C
MFP Photoconductivity	D790A/B [Req. D415, Light Source]	P790A/B [Req. Light Source]	
MFP CryoFMR	D886A/B	P886A/B	V886A/B
Optical MFP	D725A/B [Req. D415]	P725A/B	V725A/B [Req. V415]

## Sub-Kelvin Compatibility Kits

	Range	ETO (D605) / (P605)	Resistivity (D400A) / (P400A)	Heat Capacity (D650) / (P650C)	AC Suscept. for DR (D860) / (P860)
ADR	300 K – 0.1 K	Compatible	Compatible		
<sup>3</sup> He	350 K – 0.4 K	Compatible	Compatible	+ D826A/AV / P826A/AV	
DR	4 K – 0.05 K	+ D605-DR / P605-DR	Compatible	+ D856A / P856A	Compatible



\*For complete specifications, contact your local Quantum Design office.  
Specifications subject to change without notice 1084-500 Rev. D0

